

BIOGAS PLANT TECHNICIAN FIXED DOME

Learner Guide

National Vocational
Certificate Level 2

Version 1 - December 2014

Published by

National Vocational and Technical Training Commission
Government of Pakistan

Headquarter

Plot 38, Kirthar Road, Sector H-9/4, Islamabad, Pakistan
www.navttc.org

Responsible

Director General Skills Standard and Curricula, National Vocational and Technical Training Commission
National Deputy Head, TVET Reform Support Programme, Deutsche Gesellschaft für Internationale Zusammenarbeit (GIZ) GmbH

Layout & design

SAP Communications

Photo Credits

TVET Reform Support Programme

URL links

Responsibility for the content of external websites linked in this publication always lies with their respective publishers. TVET Reform Support Programme expressly dissociates itself from such content.

This document has been produced with the technical assistance of the TVET Reform Support Programme, which is funded by the European Union, the Embassy of the Kingdom of the Netherlands, the Federal Republic of Germany and the Royal Norwegian Embassy and has been commissioned by the German Federal Ministry for Economic Cooperation and Development (BMZ). The Deutsche Gesellschaft für Internationale Zusammenarbeit (GIZ) GmbH in close collaboration with the National Vocational and Technical Training Commission (NAVTTTC) as well as provincial Technical Education and Vocational Training Authorities (TEVTAs), Punjab Vocational Training Council (PVTC), Qualification Awarding Bodies (QABs) and private sector organizations.

Document Version

December, 2014
Islamabad, Pakistan

BIOGAS PLANT TECHNICIAN FIXED DOME

Learner Guide

National Vocational
Certificate Level 2

Version 1 - December 2014

Table of Contents

Purpose of this Manual.....	4
A. Course Introduction	5
A1. Name of course.....	5
A2. Overall objective of course	5
A3. Competencies gained after completion of course	5
A4. Introduction of Modules	6
A5. Course Duration.....	6
A6. Timeframe of assessment	7
Module-01: Describe basics of biogas generation and installation of biodigesters.....	8
Introduction	9
Outline of Learning Units for Module-1	12
Learning Units 1	12
Topic-1: Introduction to Biogas Technology.....	12
1.1 Biogas Production.....	12
1.2 Biogas Appliances.....	13
Learning Unit 2.....	14
Topic-1: Types of Biogas Plant.....	14
Topic-2: Functioning of a Fixed Dome Biodigester	17
Topic-3: Different Components of a Fixed Dome Biodigester	18
Learning Unit 3.....	24
Topic-1: Benefits of Biodigester Technology.....	24
Topic-2: Biogas in Pakistan.....	26
2.1 History of Biodigester Technology in Pakistan.....	26
2.2 Potential of Biodigesters in Pakistan	27
Learning Unit 4, 5, 6 and 7	29
Topic-1: Concept of Drawing.....	29
Topic-2: Drawings of Fixed Dome Biodigester.....	30
Topic-3: Drawing of Templates, Back Filling, Water Drain and Mixture	31
Learning Units 8, 9, 10 and 11.....	33
Topic-1: Selection of Biodigester Design.....	33
Topic-2: Selection of Size of Biodigester	34
Topic-3: Hydraulic Retention Time and Feeding	35
Topic-4: Basic Calculation of Quantity and Cost.....	36
Learning Units 12, 13, 14 and 15.....	39
Topic-1: Quality Standards of Construction Materials and Appliances.....	39
Topic-2: Selection of Construction Site.....	40
Topic-3: Construction Steps	42
Self-Assessment Questions for Participants – Module-1	43
Module- 02: Construct civil structural components of a fixed dome biodigester.....	44
Introduction	45
Outline of Learning Units for Module-2	47
Learning Units 1, 2, 3, 4 and 5.....	47
Topic-1: Layout and Construction of Digester.....	47
1.1. Layout Works.....	47
1.2. Excavation of Pit	48
1.3 Construction of Floor/Foundation of Digester	49

1.4 Construction of Digester Walls	50
Topic-2: Construction of Gas Holder.....	53
Topic-3: Construction of Manhole, Inlet and Outlet Chambers.....	57
3.1. Construction of Manhole and Outlet/Displacement Chamber	57
3.2. Construction of Inlet/Mixing Tank	60
Topic-4: Construction of Slurry Collection Pit and Backfilling	61
Learning Units 6, 7, 8 and 9	63
Topic-1: Importance of Quality Assurance	63
1.1. Rational	63
1.2 Quality Control Process.....	64
Topic-2: Role of Biodigester Technicians.....	66
Self-Assessment Questions for Participants	68
Module-03: Install Pipeline and Electro-mechanical Components	69
Introduction	70
Outline of Learning Units for Module-3	72
Learning Units 1, 2, 3, 4, 5 and 6.....	72
Topic-1: Installation of Pipeline and Electro Mechanical Components	72
1.1 Installation of Pipe, Fittings and Appliances	72
1.2. Installation of Gas Storage Tank	77
1.3. Installation of Biogas Filter Unit.....	78
Topic-2: Electric Appliances	79
2.1. Modification of Diesel and Gasoline Engines	79
2.2. Electricity Generation from Biogas	81
Learning Units 7 and 8	83
Topic-1: Role and Responsibilities of Biogas Technician.....	83
Topic-2: Occupational Health and Safety Measure.....	83
Self-Assessment Questions for Participants	83
Module-4: Ensure effective operation and timely maintenance of biodigesters.....	84
Introduction	85
Learning Units 1, 2 and 3	87
Topic-1: Operational and Maintenance of Biodigester	87
1.1 Checking of Gas and Water Tightness	87
1.2 Operational and Maintenance Activities	89
Topic-2: Common O & M Problems, Causes and Potential Solutions.....	104
Learning Units 4, 5 and 6	109
Topic-1: Optimum Utilisation of Biogas and Bioslurry	109
1.1. Use of Biogas	109
1.2. Use of Bio-slurry	110
Learning Units 8 and 9	115
Topic-1: Role of Technician for Security and Safety Measures	115
Self-Assessment Questions for Participants	119
Final Assessment of Competencies.....	119
Annexes	121
Annex-1: Monitoring Parameters for fixed-dome Biodigester	122
Annex-2: Tools and Equipment	124
Annex-3: Session Plan -Training of Technicians - Fixed Dome Biodigesters	128
Annex-4: Abbreviations used in the Text	124

Purpose of this Manual

Different governmental and non-governmental organisations have been supporting the promotion and extension of biodigester technology in Pakistan. More recently, The Government of Punjab has realized that bigger size biodigesters are required to meet increasing demand in the present context of energy crisis, especially in private cattle farms to use biogas for running irrigation pumps. The government envisages to install 20,000 biodigester to operate pumps for irrigation. The task of capacity building of local artisans and technicians has been given to Punjab Skill Development Fund (PSDF).

Considering that the standardization of fixed dome biodigesters is still lacking in the country, TVET Reform Support Program envisaged an initiative with a view of standardizing fixed dome biodigesters of various capacities. The first step towards this was the formulation of competency standards for (i) biogas technicians (ii) biogas technical supervisors and (iii) biodigester trainers, both on fixed dome and floating drum design of biodigesters. After the approval of competency standards, curriculum for respective trade were prepared and endorsed by National Vocational and Technical Training Commission (NAVTTTC). It is understood that in the process of building local technical skills, Punjab Skill Development Fund (PSDF) is targeting a training programme for the consulting companies that can initiate the process and provide services for the installation of such technology in the country. In this context, this manual is prepared as a reference document for local technicians (masons) to construct and operate fixed dome design of biodigester efficiently.

The success or failure of any biodigester depends mainly upon the appropriateness of the design, suitability of site for construction and quality of construction works including quality of construction materials and workmanship involved during construction, and effectiveness of operation and maintenance activities. This document highlights basics of biogas generation, the methods for selecting appropriate size and site for construction; steps of construction works; as well as operation and maintenance of biodigesters in Pakistan. This manual is prepared to assist concerned company personal, especially the local technicians, to successfully carry out their anticipated roles in effectively promoting and disseminating biodigester technology, constructing quality biodigesters and ensuring effective operation. It is expected that this manual will strength capacity of biodigester technicians in executing their anticipated tasks. This manual includes learning topics related to the following competency standards for biodigester technicians as approved by National Vocational and Technical Training Commission (NAVTTTC).

- a. **Standard-1:** Recall basic concepts of biogas production and benefits of biodigester technology
- b. **Standard 2:** Read and interpret drawings of fixed dome biodigesters
- c. **Standard 3:** Select suitable type and appropriate size of fixed dome biodigester and carry out basic calculations
- d. **Standard 4:** Select construction materials and construction site
- e. **Standard 5:** Construct structural component of a fixed dome biodigester
- f. **Standard 6:** Install pipeline, appliances and electro-mechanical components
- g. **Standard 7:** Perform routine operation and minor maintenance tasks
- h. **Standard 8:** Practice quality norms and ensure the compliance of quality standards while construction

This manual should be used in conjunction with the training curricula developed by TVET Reform Support Program and approved by National Vocational and Technical Training Commission (NAVTTTC) for biodigester technicians.

A. Course Introduction

A1. Name of course

The title of the course is '**Training of Biodigester Technicians (Masons) to Construct Fixed Dome Biodigester for Running Pumps**'. This curriculum represents plan for the term, and communicates expectations to the training participants, the local artisans. The course envisages to fulfil the following competency standards:

- a. **Standard-1:** Recall basic concepts of biogas production and benefits of biodigester technology
- b. **Standard 2:** Read and interpret drawings of fixed dome biodigesters
- c. **Standard 3:** Select suitable type and appropriate size of fixed dome biodigester and carry out basic calculations
- d. **Standard 4:** Select construction materials and construction site
- e. **Standard 5:** Construct structural components of a fixed dome biodigester
- f. **Standard 6:** Install pipeline, appliances and electro-mechanical components
- g. **Standard 7:** Perform routine operation and minor maintenance tasks
- h. **Standard 8:** Practice quality norms and ensure the compliance of quality standards while construction

A2. Overall objective of course

The main objective of the course is to enhance the knowledge and develop the skills of local artisans (i) to construct quality biodigesters, and (ii) to ensure continued operation of the installed facility, so that the users are benefitted for long run. This is expected to be useful for local artisans to gain employment as biodigester technician as specified by TEVTA and National Vocational and Technical Training Commission. The focus of the curriculum is on construction and after-sale-services of biodigesters to be installed in farms to run tube-well pumps for irrigation. The following are specific objectives:

- To familiarize the participants on Biogas Technology, in general, and Fixed Dome Biodigesters, in particular.
- To acquaint the participants on technological aspects of fixed dome biodigester, its components and working principle.
- To build skills and enhance knowledge of the participants on construction of structural components of biodigester.
- To build skills and enhance knowledge of the participants on installing pipelines, biogas-filtration devices, and end-appliances (pumps, generators, stoves, lamps etc.).
- To capacitate the participants in delivering quality services related to operation and maintenance, quality assurance, diversification of end-use applications, and users' training.

A3. Competencies gained after completion of course

The learning outcomes describe what participants should know, be able to do, and value by the end of their educational program. Within this curriculum, four general dimensions of learning outcomes are commonly identified:

- (a) Knowledge outcomes, pertaining to grasp of fundamental cognitive content, core concepts or questions, basic principles of inquiry, a broad history, and/or varied disciplinary techniques.
- (b) Skills outcomes, focussing on capacity for applying basic knowledge, analyzing and synthesizing information, assessing the value of information, communicating effectively, and

collaborating. (c) Attitudes and values outcomes, encompassing affective states, personal/professional/social values, and ethical principles. (d) Behavioural outcomes, reflecting a manifestation of knowledge, skills, and attitudes as evidenced by performance, contributions, etc.

This curriculum envisages to equip the participants with required knowledge and underpinning skills in all duties and tasks of different modules formulated for local technicians (masons) to install biodigester. After the completion of the training course, the participants will be able to: (a) explain the basics of biogas generation (b) read and interpret drawings of biodigesters, (c) carry out construction works as per set quality standards, (d) instruct users for effective operation and timely repair and maintenance, and (e) advice users for optimal utilization of the products of biodigesters -biogas and bioslurry.

The following are the specific outputs expected from the training:

- The participants will acquire detailed knowledge on biogas technology, its importance and use of biodigester products (biogas and bioslurry)
- The participants will have hands-on knowledge and skills on:
 - Reading drawings of biodigesters
 - Selection of biodigester size, construction sites and construction materials
 - Plant lay-out, digging of pits and construction of foundation
 - Construction of digester and gas storage tank
 - Construction of inlet and outlet chambers
 - Laying of pipelines and installation filtration system
 - Fitting of end-use-applications (stove, lamps, pumps and generators)
 - Construction of slurry pits and importance of composting
 - Routine operation and maintenance activities
 - Quality standards on biodigester construction, operation and maintenance
- The participants will know and realise the roles and responsibilities of local technicians to install biodigester.
- The participants will be able to orient/train users for ensure effective operation and routine maintenance activities.

A4. Introduction of Modules

Module 1: Describe basics of biogas generation and installation of biodigesters
Module 2: Construct civil structural components of a fixed dome biodigester
Module 3: Install pipeline, appliances and electro-mechanical components
Module 4: Ensure effective operation and timely maintenance of biodigesters

A5. Course Duration

The total duration of the training would be 192 hours divided in to:

- Theoretical Sessions: 48 hours
- Practical Sessions: 148 hours
- Total Duration: 192 hours (24 days)

Session details have been given in Annex-3.

A6. Timeframe of assessment

The assessment of the trainees/participants need to be carried out during the entire process of the training sessions and, at the end of the training sessions using appropriate assessment methods such as oral questions, observation of on-the-job involvement, simulations, and case studies to collect factual evidences. Methodology for assessments should be designed and used to make sure that the participants are assessed properly and relevantly. A standard checklist should be developed to facilitate the assessment process. Collection of evidence is important to assess the learning outcomes. Evidences should: (a) cover core knowledge and skills that are developed throughout the program's curriculum, (b) involve multiple judgments of student performance, (c) provide information on multiple dimensions of student performance. Good evidence is also relevant, verifiable, representative or typical, cumulative, actionable, and reflectively analyzed. The guideline for formative assessment of the learning for each module has been described in the respective module details.

Module-01: Describe basics of biogas generation and installation of biodigesters

Introduction

- a. **Title:** Describe basics of biogas generation and installation of biodigesters
- b. **Aim:** The overall objective of this module is to make trainees familiar with the process of biogas generation, importance of biodigesters and pre-requisites for installation of a fixed dome biodigester.
- c. **Duration:** 24 hours; Theory - 16 hours; Practice - 8 hours
- d. **Competency Standards**

The following four competency standards are covered under the framework of this module:

- i. **Standard-1:** Recall basic concepts of biogas production and benefits of biodigester technology
- ii. **Standard 2:** Read and interpret drawings of fixed dome biodigesters
- iii. **Standard 3:** Select suitable type and appropriate size of fixed dome biodigester and carry out basic calculations
- iv. **Standard 4:** Select construction materials and construction site

e. Learning Outcomes

After completion of this module the trainees will be able to:

1. Explain prerequisites for biogas generation
2. Describe types and functioning/ working of biodigesters
3. Describe benefits of biodigesters and importance of the technology in Pakistan
4. Describe the basic concepts of a drawing of an object
5. Demonstrate ability to read basic drawings
6. Demonstrate ability of interpret drawing of fixed dome biodigesters
7. Read and interpret drawings of templates, appliances, pipes and fittings and filter systems
8. Select suitable type of biodigester
9. Select suitable size of biodigester
10. Carry out basic calculations
11. Interpret the relation between HRT, quantity of feeding materials and required size of biodigester
12. Name different types of construction materials needed for constructing a fixed dome biodigester
13. Appraise quality standards of construction materials
14. Explain criteria for selection of construction site
15. Explain steps of construction of a fixed dome biodigester

f. Formative / sessional assessment at the end of Module-1

The following assessment methods should be used to gather evidence and a means of collecting evidence for this particular module.

- direct observation, for example:
 - reading dimension of various components in the drawings
 - work activities in a simulated workplace environment for selecting sites and construction materials
- questioning, for example:

- interviews
- self-assessment
- verbal questioning
- oral examinations
- portfolios, for example:
 - collections of work samples compiled by the candidate
 - historical evidence
 - information about life experience
- third party feedback, for example:
 - testimonials/reports from employers/supervisors
 - evidence of training
 - authenticated prior achievements
 - interview with employer, supervisor, peer

The following assessment instruments - the documented questions/assessment activities developed to support the selected assessment method/s used to collect the evidence of candidate competence could therefore be used:

- oral questions
- observation/demonstration checklists
- candidate self-assessment guides
- workplace portfolios
- simulation activities
- definition of relevant workplace documents
- evidence/observation checklists
- checklists for the evaluation of work samples

The following table summarises learning units for this module and formative assessment guidelines:

LEARNING UNIT	FORMATIVE ASSESSMENT	SCHEDULED DATES	
C1.1: Explain prerequisites for biogas generation C1.2: Describe types and functioning/working of biodigesters C1.3: Describe benefits of biodigesters and importance of the technology in Pakistan C2.1: Describe the basic concepts of a drawing of an object C2.2: Demonstrate ability to read basic drawings C2.3: Demonstrate ability of interpret drawing of fixed dome biodigesters C2.4: Read and interpret drawings of templates, appliances, pipes and fittings and filter systems	a. What is biogas? How is it generated? b. Explain major benefits of biogas technology in Pakistan. c. What do you understand by the terms the terms 'plan' and 'section' in a drawing? d. What are the major factors that need to be considered while selecting type and size of biodigester? e. What are the factors to be considered while selecting site for construction of a biodigester?		

<p>C3.1: Select suitable type of biodigester C3.2: Select suitable size of biodigester C3.3: Carry out basic calculations C3.4: Interpret the relation between HRT, quantity of feeding materials and required size of biodigester C4.1: Name different types of construction materials needed for constructing a fixed dome biodigester C4.2: Appraise quality standards of construction materials C4.3: Explain criteria for selection of construction site C4.4: Explain steps of construction of a fixed dome biodigester</p>	<p>f. What are the major construction materials needed to construct fixed dome biodigester? g. Describe the steps of construction of a fixed dome biodigesters in sequential order.</p>		
--	--	--	--

Outline of Learning Units for Module-1

Learning Units 1

Unit 1 - C1.1: Explain prerequisites for biogas generation

Topic-1: Introduction to Biogas Technology

1.1 Biogas Production

Biogas is produced by bacteria during digestion or fermentation of organic matter under airless condition (anaerobic process). The gas consists mainly of methane (CH₄) and carbon-di-oxide (CO₂). This mixture of gases is combustible if the methane content is more than 50%. Biogas from animal dung contains approximately 60% methane.

Biogas Technology includes everything which is needed to produce and utilize the products of anaerobic digestion which are biogas and bioslurry. Beside energy and fertilizer, other benefits of biogas technology are improved sanitation and environmental protection. The general conditions to produce biogas are:

- digestible substrate, i.e. organic matter plus water
- a vessel where the substrate is not in contact with air
- a digestion temperature between 15°C and 40°C
- a retention time longer than 30 days to allow the bacteria to produce the biogas. (The retention time is considerably reduced in industrial high-tech plants).

If methane producing bacteria are already present in the substrate (e.g. in dung from ruminants), biogas production begins within a week depending upon the digester temperature. At the farm site, biogas plants are daily fed and gas production is used for household purposes such as cooking, lighting and running a small engine.

The gas production potential of a certain substrate is high when organic matter content is high and the Carbon Nitrogen (C/N) ratio ranges from 20: 1 to 30: 1. The speed of the gas production depends further on the physical properties of the substrate and the temperature (optimum at 35°C). Dry and fibrous material takes longer to digest than fine-structured and wet substrate. Favoured total solid (TS) contents of the undigested substrate are between 6% and 10% which is approximately reached if dung is mixed with an equal volume of water or urine. A healthy digestion process shows a pH of 7.0 (neutral stage of substrate).

Gas production per unit of feeding material depends upon the Hydraulic Retention Time (HRT), quality of feeding and the conditions inside the digester. If the daily collectable quantity of available dung (fresh weight) is known, the gas production per day in a warm climate will approximately correspond to the following values.

Table-1.1: Gas Production Potential

Manure	Gas Production (litres) as per HRT in days				Average Dung Production by an Adult in kg/day
	25 days HRT	30 days HRT	35 days HRT	50 days HRT	
Cow	30	34	37	40	10-14
Buffalo	30	34	37	40	15-20
Horse	45	51	56	60	12-15
Chicken	60	65	69	70	0.05-0.07
Human Excreta	50	55	59	65	0.3-0.5

1.2 Biogas Appliances

Biogas Appliances are pieces of equipment for utilizing the energy of the gas. Either special biogas appliances are used or LPG equipment is adapted to operate with biogas. Biogas is mainly used in stoves for cooking and in gas lamps for lighting. Frequently, refrigerators and incubators, coffee roasters, baking ovens and water heaters, chicken or piglet heaters, Power engines for milling or generating electricity are fuelled with biogas.

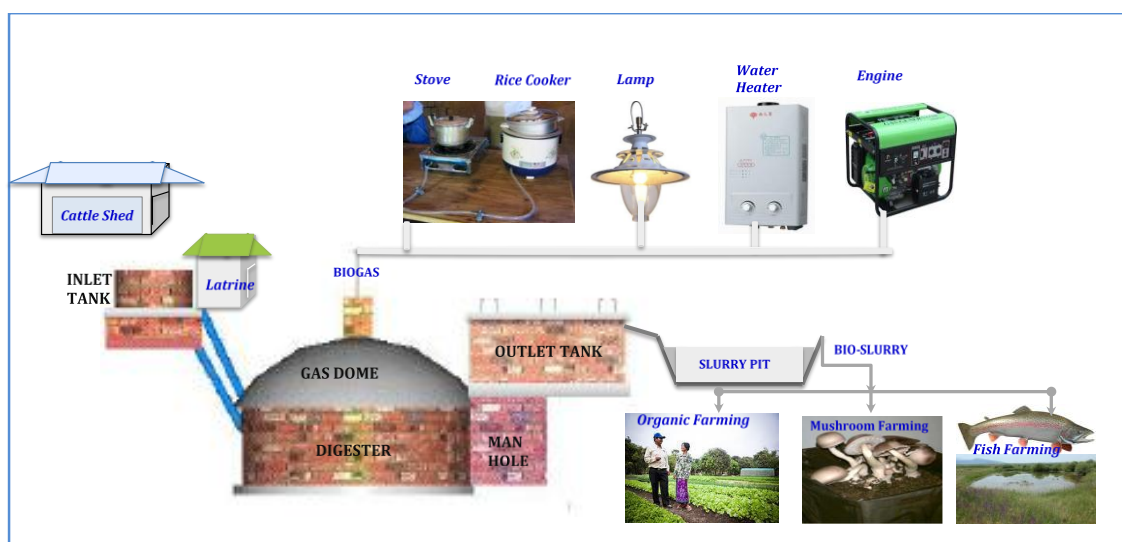

The quantity of biogas needed for various appliances are given in the table below:

Table-1.2: Gas requirements for some appliances

Appliances	Gas Requirement in m ³ /hour
Gas Burner: 5 cm	0.226
10 cm	0.280
14 cm	0.420
Mantle Lamp: Ordinary	0.071
25 watts equivalent	0.100
60 watts equivalent	0.195
Gas Refrigerator: 100 litre	0.053
170 litre	0.067
225 litre	0.078
Incubator: per m ³ capacity	0.600
Gasoline engine: Per kW output	0.569
Per rated kW	0.398
Diesel engine: Per kW output	0.700
Per rated kW	0.563

Learning Unit 2

Unit 2 - C1.2: Describe types and functioning/ working of biodigesters

Topic-1: Types of Biogas Plant

There are different designs of biodigesters being in use these days. The most popular designs are: (a) floating drum design (ii) fixed dome design, and (iii) geo-membrane design. Broadly, they can be classified based upon type of digester, type of feeding and methods of construction as described below:

a. Based upon type of gas holder

i. Floating Gas Holder

In 1956 the floating drum biogas plant, popularly known as KVIC (Khadi and Village Industries Commission) Gobar Gas plant, was introduced in India. In this design, the digester chamber is made of brick/stone masonry in cement mortar. A mild steel drum is placed on top of the digester to collect biogas produced in the digester. Thus, there are two separate structures for gas production and collection. The advantage of the floating drum design is the constant gas pressure, which is equal to the gasholder's weight divided by its surface. This means that lamps, stoves and other appliances don't need any further adjustments once they have been correctly set. Another advantage is that the level the gasholder has risen above the digester pit, is a clear indication of the available gas.



With the introduction of fixed dome Chinese model plant, the floating drum plants became obsolete because of comparatively high investment and maintenance cost.

ii. Fixed Gas holder

The fixed dome also known as Chinese model biogas plant was developed and built in China as early as 1936. It consists of an underground brick/stone masonry compartment (fermentation chamber) with a dome on the top for gas storage. In this design, the fermentation chamber and gas holder are combined as one unit. This design eliminates the use of costlier mild steel gas holder which is susceptible to corrosion. The life of fixed dome type plant is longer (over 20 years) compared to the floating drum design. The original Chinese model is usually complete made out of concrete and constructed with the help of moulds. Based on the principles of fixed dome model from China many different designs have been made in other countries.



In fixed dome plants the gas is stored in the upper part of the rigid digester structure. Fixed dome plants are sometimes called "Chinese" or "hydraulic" digesters. The accumulating gas

needs room and pushes part of the substrate into an outlet chamber, from where the slurry flows back into the digester as soon as gas is released. The volume of the outlet chamber is equal to the volume of effective gas storage. Gas pressure is created by the difference of slurry levels between the inside of the digester and the outlet chamber. The level of original filling is called the zero line. Under the airless (anaerobic) condition, biogas is produced. When the gas valve is closed, biogas collects in the upper part of the digester, called the gas storage part. The accumulating gas displaces part of the slurry into the outlet chamber. When the outlet chamber is full, slurry overflows into the slurry drain for use as manure. When the main valve is opened, the gas escapes off the gas storage part until the slurry levels inside the digester and inside the outlet chamber balances. The gas pressure depends on the prevailing difference of the slurry levels in digester and outlet.

iii. Balloon Type

This type of biodigesters use plastic membrane of different types to store biogas produced in digester. These types of digesters are low-cost, easy to install, and easy to transport into remote areas, while yielding sufficient gas for both cooking and lighting needs. However, the life-span of plastic bag digesters is relatively shorter depending upon the type of plastic membrane used.



b. Based upon type of Feeding

i. Continuous Feeding

The rural household digesters are fed once a day with the proper mix of dung and water/urine and the fresh input displaces the same volume of spent materials from the digester. Every day a certain quantity of fresh input is fed into the digester which is expected to remain in the digester for a prescribed retention time and produces gas over this length of time before being discharged.

ii. Batch Feeding

In this process the whole digester is filled with raw materials for gas production along with some starting (seed) material. This is allowed to ferment and produce gas over a certain length of time and when gas yields become very low the digester is emptied of all the sludge which can be supplied as manure. In this system, gas production begins at a low level and goes on increasing only to drop down again after reaching the peak. Because of variable gas production level, high cost and periodic emptying and filling of digesters, this process has not become popular. Examples of these digesters are small size garbage plant and crop-residues plant.

iii. Semi-batch /continuous Feeding

A combination of batch-fed and continuous fed digestion is known semi-batch or semi-continuous digestion. Such a digestion system is used where the waste like garbage etc., which are available on daily or weekly basis but cannot be reduced to make slurry. In the semi-batch system, the animal manure can be added on a daily basis after the initial loading is done with garbage, agricultural waste, leaves, crop residue and water hyacinth etc.

Likewise, based upon the methods of installation biogas plants could be classified as Pre-fabricated model and constructed in site model. Another classification could be domestic biogas plants and institutional or community biogas plants based upon the ownership of biogas plants.

The following are some of the models being used in different parts of the world.

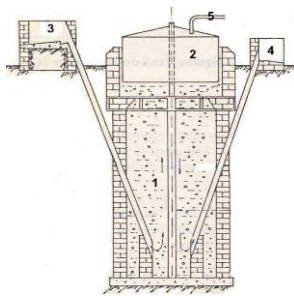

Flooding drum model (India)

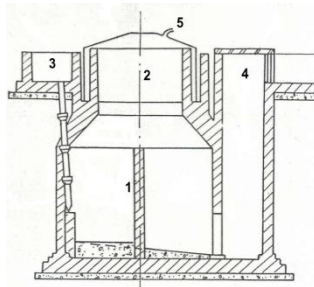

Floating drum Model (Nepal)

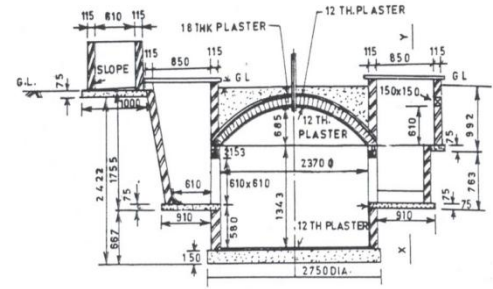

Janatha Fixed Dome (India)

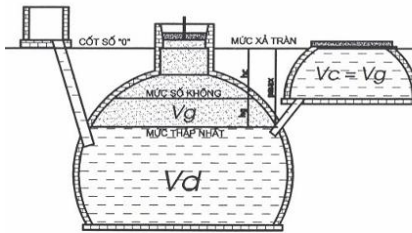

KT 1 Fixed Dome, Vietnam

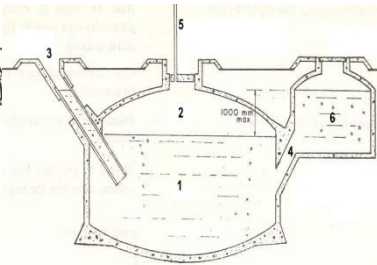

Chinese Fixed Dome

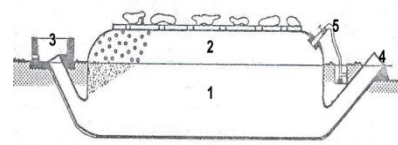

Plastic Bag digester

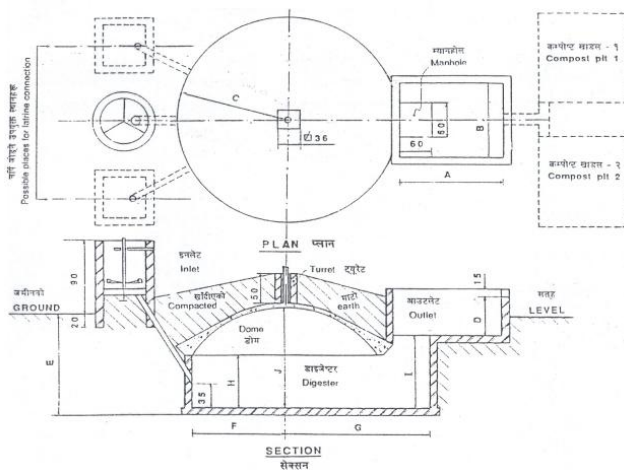

GGC Model (Nepal, Laos, Rwanda, Ethiopia)

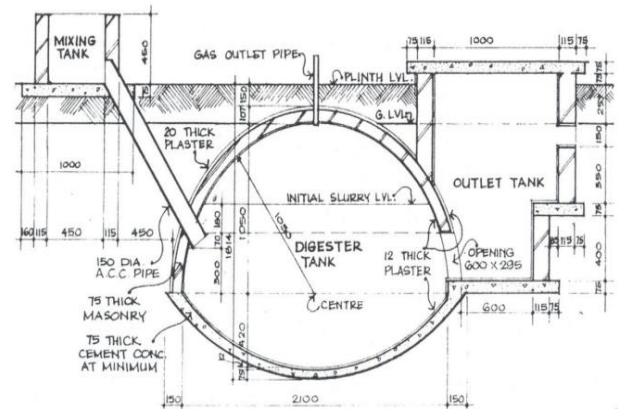

Deenbandhu Fixed Dome, India

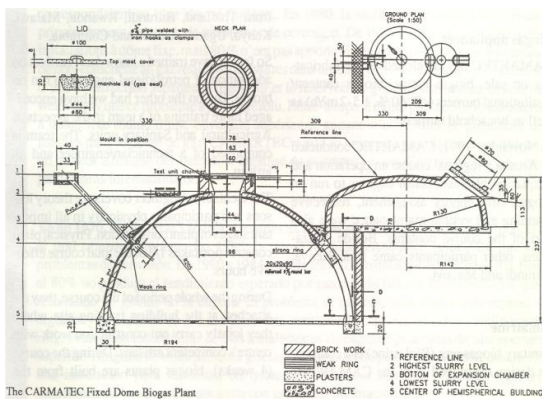

CAMARTEC and Modified CAMARTEC Biogas Plants – Tanzania, Rwanda, Ethiopia

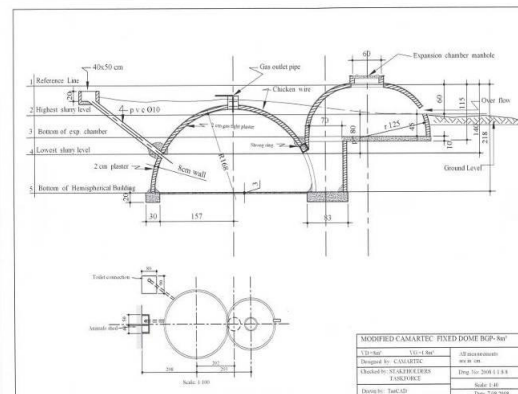

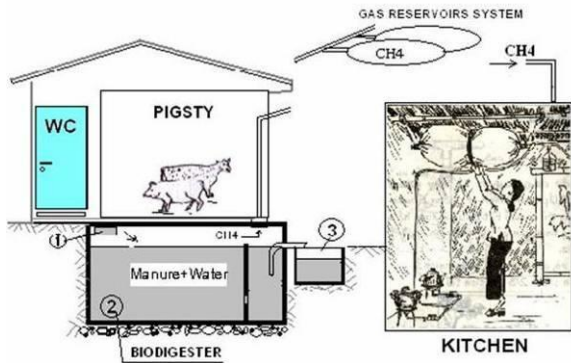

Vacvina Digester, Vietnam

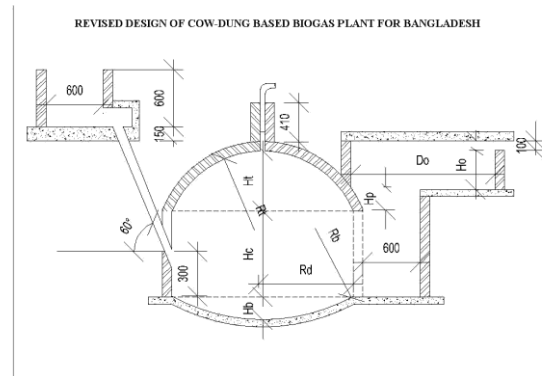

Bangladesh IDCOL Model



Prefab fibre reinforced - China



Steel Digester – Indonesia

Topic-2: Functioning of a Fixed Dome Biodigester

In the initial state of the operation cycle, the surface of the slurry in the digester and the surface of the slurry contacting with the atmosphere at the inlet and outlet are equal and are at the "zero level". At this time the biogas pressure in the digester is equal to 0 ($p = 0$).

The upper part of the digester contains a certain amount of gas. However this amount of gas cannot be extracted for consumption, as there is no pressure to push it out of the tank. This part of gas can be called "dead gas". The portion of space containing the dead gas is called the "dead portion" of the digester.

More and more gas will be generated and accumulated in the upper part of the digestion tank. It will push the slurry up to the outlet tank and the inlet pipe. As the inlet pipe is small, the volume of the slurry displaced will be mainly stored in the outlet tank. The surface of the slurry in the digester lowers down; in the meantime the surface of the slurry in the outlet tank rises up. The difference between these two surfaces represents the gas pressure. The more gas generated, the higher the pressure.

The highest level to which the slurry in the outlet tank rises is the "overflow level". At this time the level of the slurry in the digester lowers down to the "lowest level" and the gas accumulation stage of a correct operation cycle of the plant terminates here. That is the final state of the gas accumulation stage of the operation cycle. At this time the gas pressure reaches the maximum value ($p = p_{\max}$). The volume of the gas generated in the cycle is equal to the amount of the slurry displaced by the gas and kept in the outlet tank.

When the gas is released for consumption, the slurry from the outlet tank flows back into the digester tank and dispels the gas out. The surface of the slurry in the outlet tank lowers down; in

the meantime the surface of the slurry in the digester rises up. The difference between these two surfaces and the gas pressure gradually decrease.

Finally, when the difference between the two surfaces of the slurry is equal to zero, the biogas plant returns to the initial state of the operation cycle, $p = 0$ and the gas outflow stops. The volume of gas which can be extracted for consumption is equal to the volume of the slurry contained in the outlet tank.

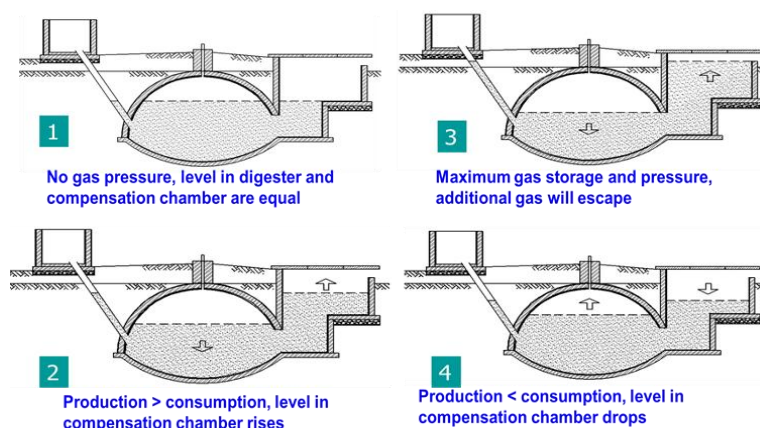

Topic-3: Different Components of a Fixed Dome Biogas Plant

The typical fixed dome biogas plant mainly consists of (i) structural components (ii) biogas conveyance system (iii) filtration systems, and (iv) end-use applications.

The **structural component** of biogas plant consists of the following sub components: (i) inlet and mixing tank with mixing device (ii) digester or fermentation chamber (iii) gas holder or gas storage tank (iv) manhole or outlet passage (v) outlet or displacement chamber or hydraulic tank, and, (vi) bioslurry collection and composting pits.

Likewise, the **conveyance system** in the biogas plant consists of: (i) main gas pipes or dome gas pipe (ii) control/regulating valves (iii) gas pipeline (iv) fittings (v) pressure gauge (vi) gas flow meter (vii) thermocouple or temperature sensors, and (viii) water outlet or water drain. The **filter system** comprises of (i) CO₂ washer/scrubber (ii) moisture filter and (iii) H₂S remover. These filter systems are also fitted with pressure gauges and indicators. The biogas **end use applications** consists of various appliances as per the need of the users, such as (i) biogas stoves (ii) biogas lamps (iii) pumps and generators.

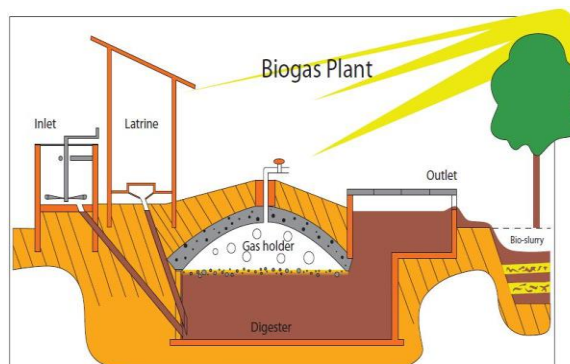

The mix of dung and water (mixed in inlet or mixing chamber) passes through the inlet pipe to the digester. Gas produces in the digester because of the microbial activities and the produced gas is stored in the gas holder (top of dome). The digested slurry passes out from digester to outlet tank (displacement chamber) and flows out to the compost pits through overflow opening in the outlet tank. The gas is then supplied to the point of application through the pipe line. A filter system is installed along the pipeline to clean the biogas if the gas is to be used for running an engine. The biogas plant generally consists of the following components as shown in the drawings below:

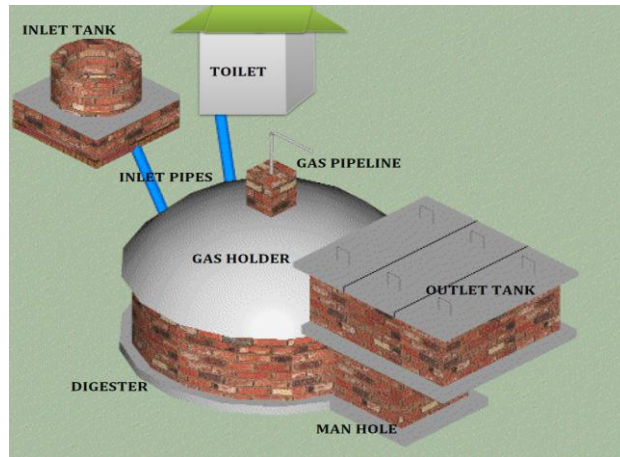

The following section briefly describes the functions of these components:

(a) Inlet/Mixing Chamber

Mixing chamber is the first structural component of a biodigester. Construction of this chamber is optional as mixing can also be carried out in the inlet tank. However, it depends on the construction site whether a separate mixing chamber is required or not. Mixing chamber is constructed when it is not feasible to transport manure and water directly to the inlet due to distance or and other prohibiting factors.

The manure inlet is meant for daily feeding of plant according to its requirement based on calculated retention time. Inlet is designed according to the feed size of digester in order to reduce the human error as well as increases the efficiency of gas production. A 50 m³ biodigester requires a daily input of 400-500 KG of cattle dung that has to be mixed with equal volume of water. Mixing device is used to prepare good quality water-dung solution in the inlet tank when cattle dung is used as feeding material. Usually for household biodigesters, vertical mixing devices are installed and for bigger plants, horizontal devices are used. A small electric motor of 1-2 HP could be fitted to facilitate the mixing. The device should be of good quality, as per the design, and the mixing blades have to be well galvanised. The blade should be properly aligned for the effective mixing.



(b) Digester/Digestion Chamber

Digester is the place where anaerobic fermentation takes place and biogas is produced by the microbes in the absence of oxygen. The feeding (dung-water mix) remains in digester for at least 40 days (its retention time). The digested slurry leaves this chamber through the manhole opening.



(c) Gas Holder

Biogas produced in the digester is stored in the gas holder which is constructed on the top of digester in spherical shape. Gas holder is generally constructed of plain cement concrete for smaller sizes of biodigesters (less than 20 m³) and with reinforced cement concrete for larger size of biodigesters. The gas holder is fitted with the main gas pipe to facilitate the flow of biogas to the point of application.



(d) Outlet tank or Displacement Chamber

The digester slurry from the digester passes through the manhole and gets collected in the outlet tank which is also known as displacement chamber or pressure tank of hydraulic tank. The size of the outlet tank and the height of the slurry in the tank determines the pressure of biogas at the point of application. The higher the level of slurry in the outlet the more will be the pressure. The slurry collected in the outlet tank comes out of the tank by virtue of the gas pressure via overflow opening which is then collected in a slurry pits for composting. When the outlet tank is full and slurry is coming out of biogas plant, it indicates that the gas storage tank is full. The shape of outlet tank could both be rectangular or circular as shown in the picture below:



(e) Bioslurry Pit/Composting Pits

The fully digested light weight slurry that comes out of outlet tank is collected in bioslurry pits. This slurry is ready-to-use as fertilizer for the crops as pure organic fertilizer having high ratios of NPK. Sometimes bioslurry is directly conveyed to the point of application via pipes or irrigation channel without constructing bioslurry collection pits.



(f) Pressure gauge/pressure meter

The gauge is installed at the top of gas holder to measure pressure of the gas inside the gas holder. U-shaped pressure gauge (manometer) made up of a transparent plastic or glass tube and filled with coloured water or a clock-type digital or analogue pressure meter could be installed in the conveyance system to monitor the pressure of gas. Whatever may be the type this device should best among those available in the local market and should meet set quality standards, if any. Biodigester Construction Company (BCC) has to train the plant operator regarding the usage of gas according to the reading of pressure gauge.

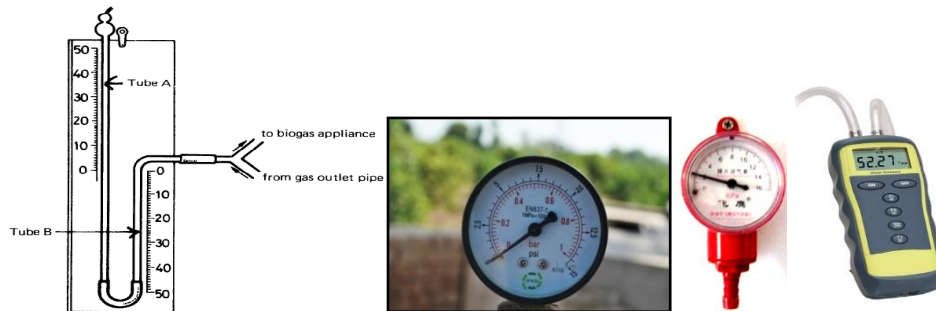

(g) Thermometer/Temperature Gauge

Thermocouple type temperature sensor is installed to measure the inside temperature of the digester which is indicated on the temperature gauge installed at a suitable place on the plant. Suitable temperature for the efficient production of biogas is between 20-40 C°. A variation in the inside temperature can cause loss of gas, hence the operator is trained to ensure the ideal temperature inside the digester



(h) Biogas Flow Meter

The flow meter provides reading of the gas that has been produced by the plant and used/ stored in a gas storage tank. BCC should train the plant operator to notice the flow of this meter and assure the gas is being produced at optimum level, and to take measures in case gas flow is not up to the standards. In case the gas is being stored in a tank, the operator must switch OFF the compressor when the pressure on indicated on the pressure gauge reaches a certain level. This is mandatory to avoid the slurry flow into the gas line.



(i) Safety Valve/Main Valve

This is the main valve installed on top of the gas holder to handle the gas according to the pressure. It controls the flow of biogas in the pipeline from the gas holder. It is opened when gas is to be used and closed after each use. If substandard quality of main gas valve is used, there is always risk of gas leakage. This valve should be of high quality.



(j) Pipes and fittings

The pipe to be used to convey gas from gas holder to the point of application should conform to quality specification as per the standard. Light quality Galvanized Iron pipe is best suited for this purpose; however, high quality PVC pipe could also be used. The pipe should be of at least half inch diameter. For length of more than 60 m (30 m if two burners are to be used at a time), 3/4" diameter pipe has to be used. If GI pipe is to be used, a six meter pipe should weigh at least 6 kg. The fittings used in the pipeline of a biogas plants are socket, elbow, tee and nipples. These fitting should meet the required quality standards.



(k) Water Outlet

It drains water condensed inside the pipeline when biogas comes in contact with the cool pipe. It should be easy to operate and threads in it should be perfect. It should be ensured that the hole in the screw nut is bored properly and is located at the right place. The thickness of the nylon washer has to be 4mm and either a 4 cm long handle pin or a properly knurled opener should be used. Water drains are installed in domestic biogas plants, however, for institutional and commercial biogas plants to be used for electricity generation, moisture filter has to be installed.



(l) Gas Tap

Gas tap is used for regulating flow of gas to the gas stove. Care should be taken to install gas tap of high quality. It has been often complained by the users that this taps are becoming problematic with gas leakage through them. It is important that the 'o' ring is placed properly and is greased thoroughly and regularly. The gas tap should not be too tight or loose to operate. The taps to be used in biogas plants should be approved by concerned quality control authority.



(m) Rubber Hose Pipe

It is used to convey gas from the gas tap to the stove. This pipe should be made up of high quality neoprene rubber and should not develop cracks when folded. It should have 15 mm outer and 9 mm inner diameters. The minimum wall thickness of the pipe should be 2.5 mm.



(n) Gas Stove

Gas stoves can be found with single and double burners. In general a single burner gas stove used for household purpose consumes 350 to 400 litre of gas per hour. The efficiency of gas stove is very important for the successful functioning of the biodigester. The stove should be of good quality and strong enough to firmly rest in ground. The primary air intake should be easily adjustable and the holes should be properly placed. The jet and pipe leading to the burner should be straight and aligned properly. The holes in the burner cap should be evenly spread across it.



(o) Gas Lamp

Gas lamp is another important appliances used in biodigesters. Often users complain about the malfunctioning of these lamps. These lamps should be of high quality with efficiency more than 60%. Usually, a biogas lamp consumes 150 to 175 litres of biogas per hour. Lamps to be used in biodigesters have to be approved by the concerned quality control authority.



(p) Filter Systems

To use biogas for operating an engine, carbon-di-oxide (CO_2), hydrogen sulphide (H_2S) and moisture should be removed from biogas. For these purposes, filters are fabricated and installed along the pipeline. There are three main filter units commonly called as: (a) CO_2 scrubber/washer (b) H_2S filter and (c) moisture absorber.



(q) Biogas Engines

Biogas can be used in both CI (compression ignition) engines and SI (spark ignition) engines. In other words, biogas can be used to run either gasoline generators or Diesel (Petter) Engine coupled with an induction motor as shown in the following pictures. The self-ignition temperature of biogas is high and hence it resists auto ignition, this is desirable feature in spark ignition engines, as it will reduce the chances of knock. SI engine conversion to biogas fuelling involves some engine modifications.



Learning Unit 3

Unit-3: C1.3 - Describe benefits of biodigesters and importance of the technology in Pakistan

Topic-1: Benefits of Biodigester Technology

Biogas Technology has a very significant role to play in integrated agricultural operations, rural sanitation, dairy farms & sewage disposal etc. It is estimated that cattle dung, when passed through a biodigester, yields 30-40% more net energy and about 35-45% more Nitrogen in manure as compared with that obtained by burning dung cakes and ordinarily prepared compost, respectively. Besides, from a biogas plant both the products are obtained. The following are major benefits:

- The Biogas plant converts cattle dung into two useful products viz.: inflammable gas (biogas) and good quality manure.
- Biogas provides a smokeless high efficiency fuel for cooking, lighting and motive power.
- The manure obtained from biogas plant has higher nutritive value as compared to that of ordinary farmyard manure.
- Biodigesters keep the household and surroundings clean.
- Biodigesters prevent deforestation.
- Biodigesters control environmental pollution and promote public health.

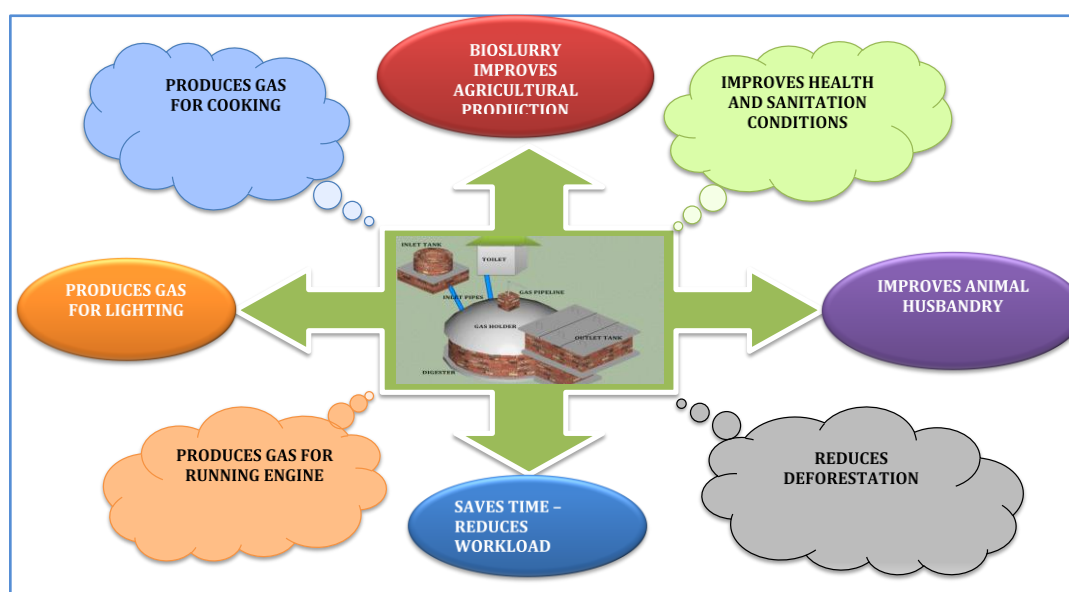

On an average, a biogas plant serving a household of 5 or 6 people generates the following, main benefits:

- Reduction of workload: 1.5 to 3 hours/day
- Saving of traditional cooking fuel such as firewood: 3,000 to 4,000 kg/year
- Reduction of greenhouse gasses: up to 6.0 ton of CO₂ equivalent/year
- Reduction of indoor air pollution: 3 persons/household are less exposed
- Toilet attachment: Improvement in household sanitation and health conditions
- Potential increase of agricultural production or saving on the use of chemical fertiliser (biogas plants produce high quality organic fertilizer–bio-slurry): up to 40%
- Improved sanitation, less pollution to underground water

One Cum of Biogas generates 5000 to 6000 kcal of heat which is enough for:

- Replacing 4-5 kg of firewood
- Replacing 0.6 to 0.7 litre of kerosene
- Replacing 1.6 kg of charcoal
- Replacing 0.45 kg of LPG
- Burning stove for 2.5-3 hours
- Burning lamp for 5-6 hours
- Run 1hp engine for about 2 hours

Therefore biogas plant provides multifaceted benefits. Some of the economic, health, environmental and social benefits at households as well as community level have been described below:



a. Economic Benefits

- Saving of expenditures on fuel sources
- Saving time to utilize in other income generation activities
- Enhanced soil productivity because of the use of bio-slurry (added N,P,K values)
- Reduction in the needed quantity of chemical fertilizers, due to the use of bio-slurry
- Reduction on health expenditures due to a decrease in smoke-borne diseases
- Local employment creation
- Private sector development that produces economic goods
- Livestock development
- Income generation through selling of carbon credits (CERs and VERs)

b. Health Benefits

- Reduction in smoke-borne diseases (headache, dizziness, eye-burning/infection, respiratory tract-infection, etc.)
- Improved household sanitation due to attaching of latrines to bio-digesters, absence of soot, ashes and firewood in the kitchen
- Decrease in burning accidents

c. Environmental Benefits

- Preservation of forest
- Increase in soil productivity due to added NPK by using slurry and agricultural residues
- Reduction in green-house gases, especially methane
- Prevention of land-fertility degradation due to the excessive use of chemical fertilizers

d. Social Benefits

- Extra time for social activities
- Enhanced prestige in the community
- Workload reduction (less time spent on firewood collection and cooking)
- Bright light to help in quality education and household works

Topic-2: Biogas in Pakistan

2.1 History of Biodigester Technology in Pakistan

The history of biogas technology in Pakistan is about 40 years old. Around six thousand digesters were reportedly been installed across the country till the end of 2010 as against the technical potential of about five million digesters based on its suitable climate and availability of feedstock, the cattle dung.

The Government of Pakistan started a comprehensive biogas scheme in 1974 and commissioned 4,137 biogas units by 1987 throughout the country. These were large floating drum biogas plants with capacity varying from 5-15 cubic meters gas production per day. This programme was implemented in three phases. During the first phase, 100 demonstration units were installed under grant by the government. During the second phase, the cost of the biogas was shared between the beneficiaries and the government. In a subsequent third phase, the government withdrew financial support for the biogas plants, although technical support continued to be provided free of cost. Unfortunately, after the withdrawal of the government financial support, the project did not progress any further (World Energy Council).

The Pakistan Centre for Renewable Energy Technologies (PCRET) is the leader in the country to disseminate biogas technology and has supported installation of around 1600 biogas plants till the end of 2006. In addition to these 1600 household biogas plants it has installed, PCRET has plans to install another 2,500 plants by 2008 for which Government of Pakistan has approved financial support.

The Initiative for Rural and Sustainable Development (IRSD), an NGO, has installed around 150 biogas plants with support from the UNDP Small Grants Program. Some Regional Support Programmes and NGOs have also included biogas among the projects they support. The NGO 'Koshis' in Sialkot, Punjab has reportedly helped villagers to build over 200 biogas plants. Another NGO Green Circle Organization is building community based plants with funding from the Pakistan Poverty Alleviation Fund. Most NGOs received technical assistance from PCRET in the design of their plants. With some exceptions most plants are still installed on a pilot basis and have not been promoted commercially to any large scale.

Most of the biogas plants installed in recent years have been smaller household designs (3 to 5 m³ gas production per day) compared to the larger plants in the 1970s and 1980s. The biogas technology most commonly used in Pakistan is the floating drum design. Another design, Chinese fixed-dome design, was reported to be installed on a pilot basis but was reportedly not successful. The Chinese design pilot biogas plants apparently showed persistent leakage and seepage problems and moreover the gas pressure was reported to be low.



Twelve fixed-dome 'Nepalese design' biogas plants of Model GGC 2047 of 6m³ were installed in tehsil Pasrur of Sialkot District in partnership with the Punjab Rural Support Program (PRSP) and four plants of the same design were installed in sizes 8 (2 nos.), 20 and 35 m³ in Dera Ismail Khan in partnership with the Foundation for Integrated Development Action (FIDA) by the Rural Support Programme-Network (RSPN) in June of 2007. FIDA was reported to have plans to continue supports to install biogas plants in its working areas.

Rural Support Program Network with Support from SNV Netherlands Development Organisation commenced Pakistan Domestic Biogas Program (PDBP) in 2009. A total of 5000 biogas plants have reportedly been installed in different districts in Punjab till the end of 2013.

Other organisations such as WINROCK International is supporting the installation of medium scale biodigesters in dairy farms.

2.2 Potential of Biodigesters in Pakistan

Biogas dissemination requires definite background conditions for its success. The reality of a location will be shown by favourable and unfavourable factors. It is the job of the programme personal to judge this mixture in favour of or against possible biogas dissemination.

Following, are the criteria which make biogas dissemination impossible or more difficult. The ideal project location will rarely be found. The "ideal conditions" stated are to make the individual factors clearer.

a. Excluding factors

If only one of the following criteria is evident, then the dissemination of simple household biogas plants is not possible (As an exception, suitable farms in the region could allow individual measures under some circumstances.)

- too cold or too dry region
- very irregular or no gas demand
- less than 20 kg dung/day available to fill the plant or less than 1,000 kg live weight of animals per household in indoor stabling or 2,000 in night stabling.
- no stabling or livestock in large pens where the dung cannot be collected
- no building materials available locally
- no water available
- integration of the biogas plant into the household and farm routines not possible
- no suitable institution can be found for dissemination

b. Critical factors

Each of the following factors will lead to great problems in biogas dissemination. Accompanying measures, particularly modified technical developments, high financial promotion or additional organisation structures within the dissemination programme are necessary to guarantee project success.

- low income or unstable economic situation of the target group
- unfavourable macro and microeconomic coefficients
- gas appliances not available regionally or nationally
- irregular gas demand

- very good supply of energy throughout the year and simultaneously only moderate economic coefficients for the biogas plant
- high building costs
- low qualification of artisans
- counterpart organisation has only indirect access to the target group
- weak structure of the counterpart
- no substantial interest of the government is evident over the medium term
- low regional or national potential

c. Ideal conditions

If each of the following conditions is fulfilled then household biogas plants will definitely get a foothold. A dissemination programme is then expressly recommended:

- even, daily temperatures over 20°C throughout the year
- regular gas demand approximately corresponding to gas production
- full stabling of animals (on solid floors as far as possible)
- at least 30 kg/day dung available per plant
- dairy farming
- use of organic fertiliser is normal
- farmers are owners of the farm system and primarily of the farm
- plants can be located in favourable positions to the stables and to the point of gas consumption
- the biogas plant can be integrated into the normal working routine in the house and on the farm
- gas utilisation and attendance of the plant can be clearly regulated within the household
- low price of plant in relation to the income of the target group
- favourable economic coefficients for the biogas plant
- economically healthy farms open to modernisation
- insufficient supply of fossil sources of energy
- building materials and gas appliances available locally
- qualified artisans locally
- counterpart organisation has access to and experience in contact with the target group
- efficient counterpart organisations with the possibility of cooperating with the private sector
- counterpart organisation has experience in programmes comparable to biogas dissemination
- political will on the part of the government towards not only biogas technology but also towards strengthening small and medium-scale farm systems
- secured financing of the dissemination structure

Based upon the detailed market study carried out by SNV/Winrock, Pakistan has the potential of 5,000,000 biogas plants across the country.

Learning Unit 4, 5, 6 and 7

Unit 4 - C2.1: Describe the basic concepts of a drawing of an object

Unit 5 - C2.2: Demonstrate ability to read basic drawings

Unit 6 - C2.3: Demonstrate ability of interpret drawing of fixed dome biodigesters

Unit 7 - C2.4: Read and interpret drawings of templates, appliances, pipes and fittings and filter systems

Topic-1: Concept of Drawing

Since earlier times, people have used drawings to communicate and record ideas so that they would not be forgotten. The earliest forms of writing, such as the Egyptian hieroglyphics, were in illustrative/graphic form. The word graphic means dealing with the expression of ideas by lines or marks impressed on a surface. A drawing is a graphic representation of a real thing. Drawing therefore is a graphic language, because it uses pictures to communicate thoughts and ideas. Because these pictures are understood by people of different kinds, drawing is referred to as a “universal language.” Artistic drawing is concerned mainly with the expression of real or imagined ideas whereas technical drawing is concerned with the expression of technical ideas or ideas of a practical nature, and it is the method used in all branches of technical industry.

There are four different types of projections when it comes to technical drawings; 1. Orthographic Projection, 2. Isometric Projection, 3. Oblique Projection and 4. Perspective Projection. The most used projection in the technical drawing is the Orthographic Projection. Orthographic Projection must contain three dimensions; length, width and depth or height. In order to include all the required three dimensions, an Orthographic Projection contains two views: Plan View and Section view. Plan view provides the length and width of the subject while section view provides the depth or height.

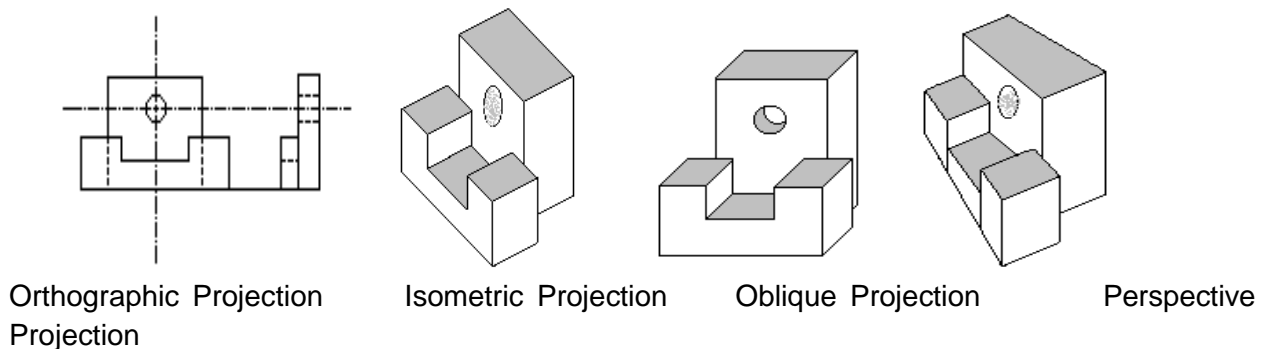

Such technical drawing will only be considered complete when all the dimensions are indicated in the drawn subject, since without dimensions the subject cannot be constructed in the correct proportion. The lines that indicate measurements of the subject in the drawing are called dimension lines. Dimension lines can be drawn in different styles such as:

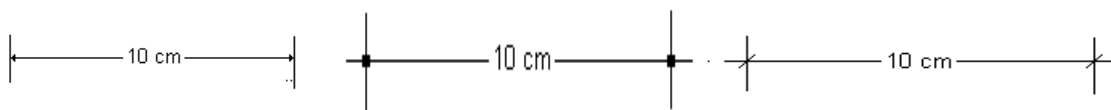

Topic-2: Drawings of Fixed Dome Biodigester

As described in earlier chapters, a fixed dome biodigester consists of various components such as inlet, digester, gas holder, man-hole, outlet tank, overflow opening and compost pits. Sample drawing of a GGC model fixed dome biodigester is given below:

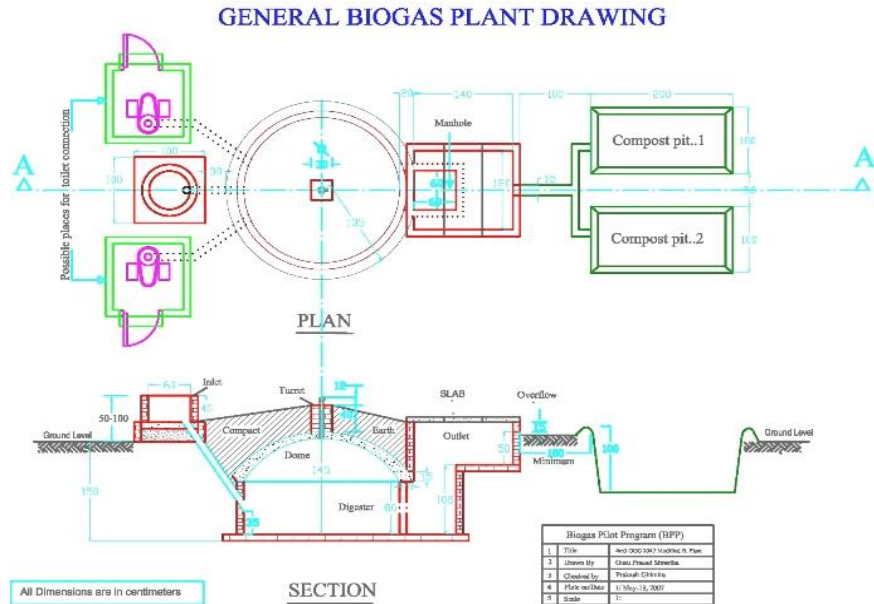

The following pictures show front elevation, sectional view and isometric view of a GGC fixed dome biodigester.

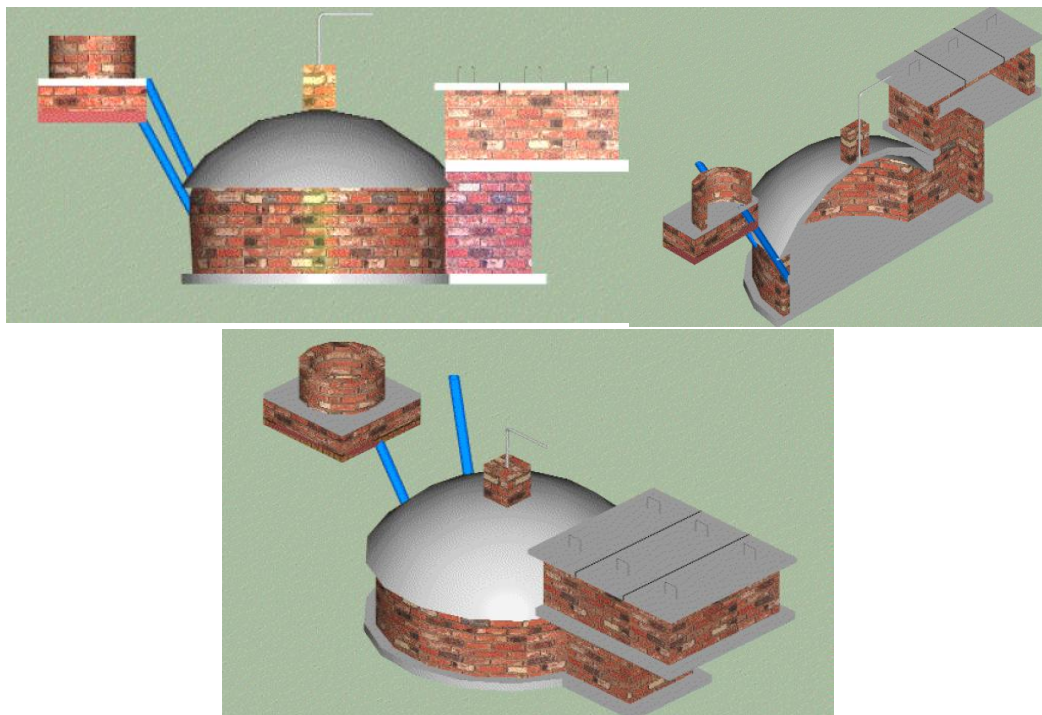

The following drawing shows rectangular outlet of a biodigester:

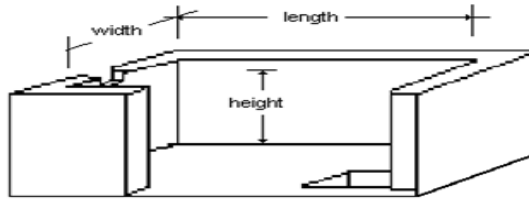

Drawings and dimensions of different sizes of GGC biodigesters are given below:

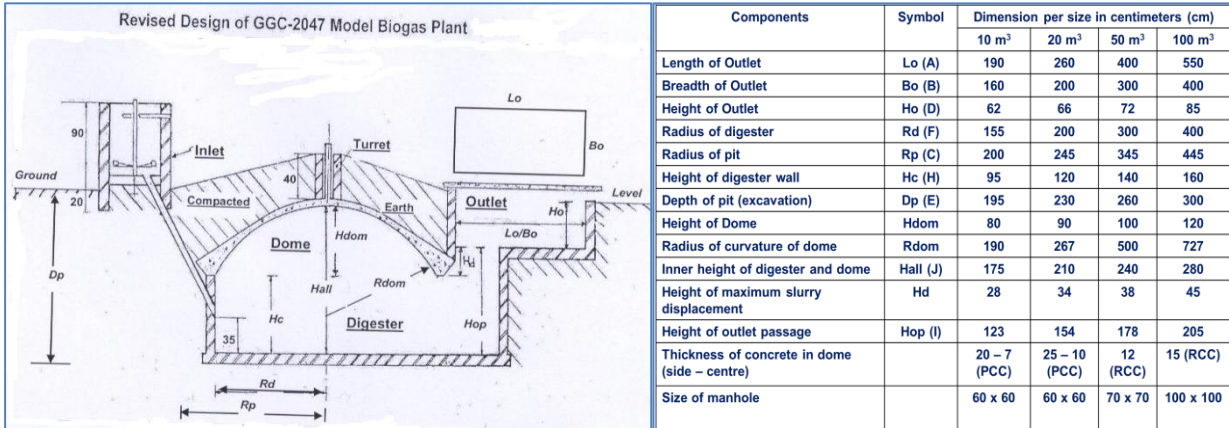

Topic-3: Drawing of Templates, Back Filling, Water Drain and Mixture

While constructing fixed dome biodigesters, standard templates are used to prepare a mould for the gas holder. Size of these templates varies from one size of biodigester to the other. Likewise, there is need to understand drawings of various components such as top filling over dome, inlet and mixing arrangement, and water drain arrangement. The drawings of these components are given below:

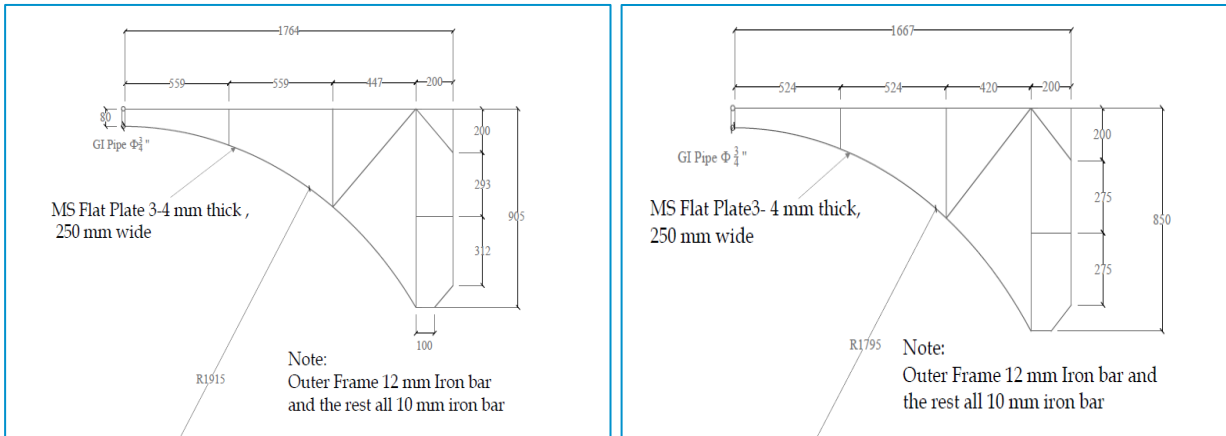

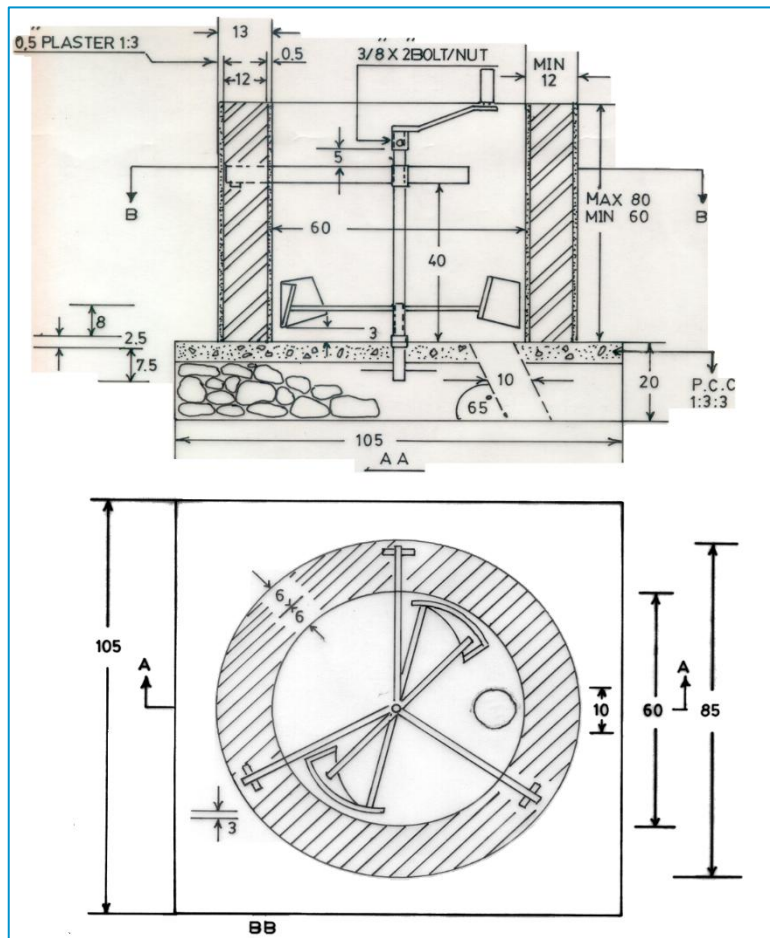
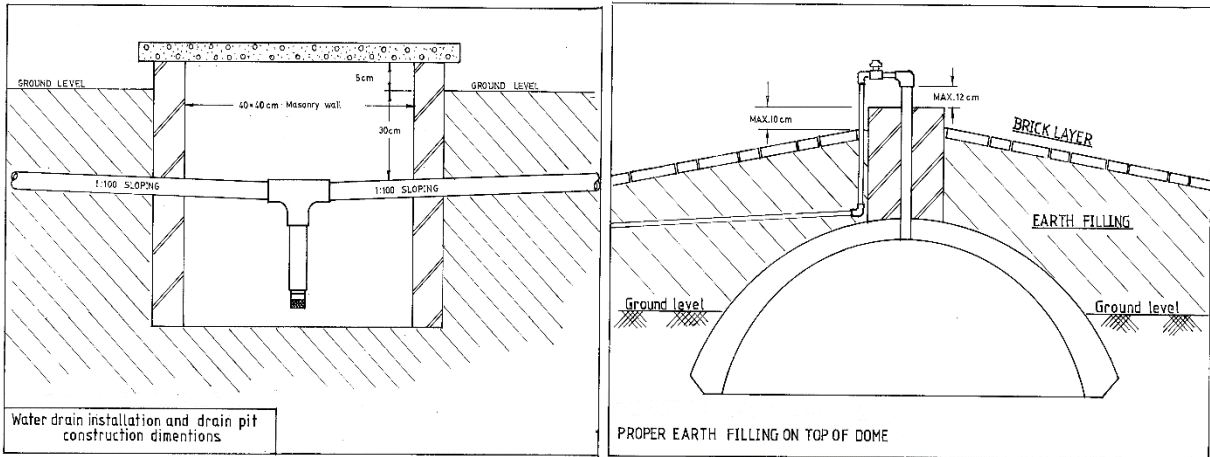

Inlet – Mixing Arrangement

Learning Units 8, 9, 10 and 11

Unit 8 - C3.1: Select suitable type of biodigester

Unit 9 - C3.2: Select suitable size of biodigester

Unit 10 - C3.3: Carry out basic calculations

Unit 11 - C3.4: Interpret the relation between HRT, quantity of feeding materials and required size of biodigester

Topic-1: Selection of Biodigester Design

To successfully achieve anticipated objectives of any biogas programme, it is imperative that the best suited model/design of biogas plant is selected for the wide-scale dissemination. Varieties of models/designs of biogas plants are being used in different countries in the world with successful track records. The following factors should be considered to evaluate the suitability of biodigester assuming that the adaptability of any biogas plant in a given context depends mainly upon these factors.

- a. Climatic and geo-physical parameters
 - Ambient temperature
 - Geo-physical conditions of the soil
 - Condition of ground water-table
- b. Technological Parameters
 - Structural strength against different load conditions (structural durability)
 - Methods of construction/supervision
 - Time and effort in quality control
 - Methods of operation and maintenance
 - Applicability/adoptability of the design in different geographical context for mass dissemination
 - Prospects for sharing of technical information and know-how
- c. Affordability of potential farmers to install biogas plant
 - Availability of construction materials
 - Availability of human resources (skilled and unskilled) at the local level
 - Cost of installation, operation and maintenance
 - Transportation facilities
- d. Purpose of the use of the products from biogas plant
 - Use of gas for cooking, lighting and/or operating a dual-fuel engine
 - Use of slurry as organic fertiliser
- e. Performance of existing models, if any, in the local and/or regional conditions
 - Existing physical status and functioning
 - User's level of satisfaction
- f. Quality and quantity of available feeding materials
 - Type of feeding materials (cattle dung, human excreta etc.)
 - Availability of water for mixing
 - No. of cattle per household

Keeping in view the above factor, fixed dome biodigesters could be one of the better options to be disseminated in Pakistan. There are different models of fixed dome biodigesters being disseminated in different countries across the world. Based upon the performance of the

existing plants and experiences from other biogas countries, attempts should be made to select the best model for the wide-scale dissemination of the biogas technology in the country.

The following are the main characteristics of fixed dome biodigesters.

- reliable, durable and user-friendly: the digesters should have an estimated lifetime of over 20 years with a minimum of maintenance;
- replicable: with local available material and local skilled manpower, the digesters must be able to be constructed nationwide;
- adaptable to local conditions (climatic and soil conditions, water levels, quality and quantity of feeding material, etc.);
- affordable: the cost of the digesters are relatively less keeping in view to its durability.

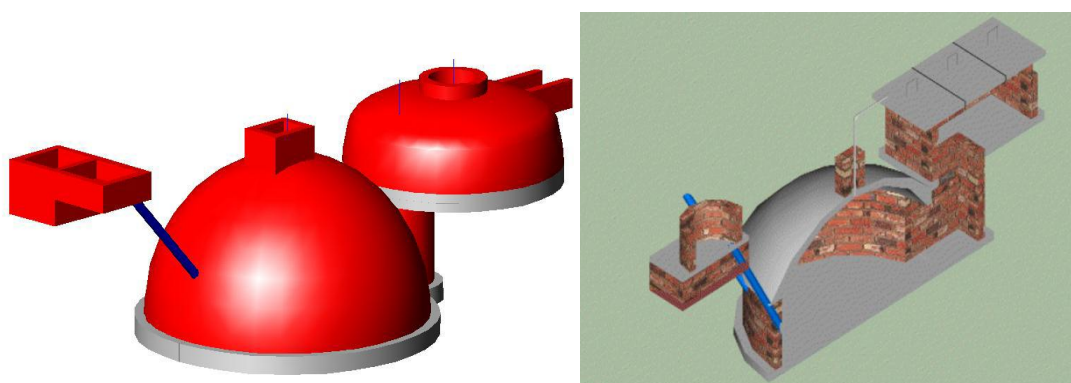

The fixed dome plant, comprises a closed digester with a fixed, non-moving gas space and a compensating tank. The gas is stored in the upper part of the digester. Gas production increases the pressure in the gas space of the digester and pushes the slurry into the compensating tank. When the gas is extracted, a proportional amount of the slurry flows back into the digester.

Topic-2: Selection of Size of Biodigester

A number of factors need to be considered while determining the size of biodigesters. Main factors are listed below:

- a) Number of cattle heads,
- b) Type and size of livestock,
- c) Livestock feeding practice
- d) Type of cattle shed (ease in collection)
- e) Livestock grazing practice (open-grazed or stall-fed),
- f) Gas Demand (in case of plenty of cattle)

Selection of proper size is essential to meet the technical and the financial issues as given below.

Financial Aspects:

- a) Plant becomes expensive,
- b) Results in unnecessary workload and financial burden,
- c) Unsatisfactory rate of return on the investment.

Technical Aspects:

- a) Under-fed biodigesters resulting in reduced gas production,
- b) Over-fed biodigesters resulting in bacteria wash-out and escape of methane

- c) Improper functioning of biogas plant due to less pressure,
- d) Slurry entrance in the pipe line OR gas escaping from the outlet.

The size and dimensions of the biodigesters are usually decided based upon 45-50 days retention time and 60% gas storage. This means that the fresh feeding fed into the digester should remain inside it for at least 45 days before it comes out through outlet. Likewise, the effective volume of gas holder should be able to store 60% the gas produced in 24 hours. Therefore the size of the biodigester has to be selected based upon the daily available quantity of feeding materials. Before deciding the size of biodigester to be installed, all the dung available from cattle has to be collected and weighed for at least a week to know how much feeding material is actually available every day.

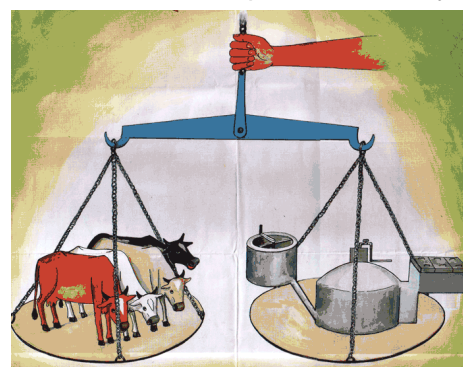

If the plant is not fed properly as per the requirement, gas production will be less than the theoretical expectation. If gas production is less, the gas collected in the gasholder will not have sufficient pressure to push the digested slurry to the outlet. In such case, the slurry level will be raised and reach to the gas holder instead of flowing to outlet. When the main gas valve is opened in this situation, the slurry may pass to the pipeline together with the gas. Therefore, if there is not enough quantity of feeding material available as per the prescribed rate, bigger size of biodigester should not be installed. Underfed and bigger plants will just increase the cost of installation and also create problems in operation. **If the farmer has higher number cattle then only the size is determined by the gas demand which is usually taken to be 0.30-0.40 m³ gas per person per day or 0.5 m³ per hour per horse power of engine capacity.** To calculate the actual gas demand in a house or farm it is necessary to estimate the total energy consumption. For this all the end use applications and hours of operations should be plotted.

Table-1.3: Plant Size and Potential of Gas Production

Collectable Dung Kg/ day	Water Litres/ day	Capacity of Plant M ³	Initial Feeding of Dung Kg	Daily Gas Production M ³ *	Electricity Generation Potential per/day (Units) **
80-100	80-100	10	3,200	3.2-4	5-6
160-200	160-200	20	6,500	6.4-8	10-12
240-300	240-300	30	10,000	9.6-12	15-18
320-400	320-400	40	13,000	12.8-16	20-24
400-500	400-500	50	16,000	16-20	26-32
600-750	600-750	75	24,000	24-30	38-48
800-1000	800-1000	100	32,000	32-40	52-64

*Gas production depends upon the ambient temperature, type of feed etc.

**It is electricity generated by using biogas in a gas generator. When biogas is used mixed with diesel fuel, the total electric energy generated depends upon the ratio of the two fuels in a dual mode.

Topic-3: Hydraulic Retention Time and Feeding

Hydraulic Retention Time (HRT) can be defined as the total time required by a given amount of dung to produce approximately 80 to 85% of the total gas. Thus HRT is also the time spent by the feed inside the digester before it is completely digested. The HRT is highly determined by

the temperature of slurry and the digester volume. The digester volume is generally chosen so as to retain the daily feed in the digester for a period equal to the HRT so that most of the slurry is digested. As the HRT depends largely on temperature, retention periods differ from place to place. For the context of Pakistan, the biodigesters are designed with a HRT of 40-50 days.

In practice, the decomposition process of feedstock is lower than anticipated due to the changed in ambient temperature. For animal manure decomposition period could be the months. For wastes from plants, this period is longer than that of manure, even few months. However, the speed of biogas production is the highest in the beginning two to three weeks and then reduces sharply as the days increases. Hydraulic Retention Time (HRT) is the time needed for the full digestion of feeding materials inside the digester which mainly depends on:

- Type of feeding material – quantity and quality
- Total Solid percentage in the feeding material
- Temperature in the digester
- pH Value of the feeding

HRT in Pakistan context for cattle dung digestion is assumed to be 50 days. The feeding material that enters into the digester from inlet should remain in the digester for 50 days to release all the gas inherited by it. HRT is therefore the time needed by the slurry to traverse from one side of the digester to the opposite side assuming the flow is laminar. To avoid short-circuiting of slurry (coming out of digester without giving-up the whole quantity of biogas), the location of the plant components has to be as given in the drawing.

If HRT is higher than the assumed, slurry remains in the digester even after releasing all the gas inherited by it creating a dead volume in the plant. If low, slurry comes out of the plant before releasing all the biogas inherited by it, causing deficiency of gas and foul odor in the surrounding. Bacteria flush-out will be a common phenomenon.

HRT could be adjusted by changing the quantity of daily feeding. To maintain the designed HRT of 50 days, specific amount of dung mixed with equal quantity of water has to be fed into the digester. The following table shows the quantity of cattle dung for different capacity of biodigesters to ensure a HRT of 50 days.

Table-1.4: Recommended Feeding of Biodigester

Quantity of feeding material available daily (kg)	Recommended Size of Plant (m ³)
80-100	10
160-200	20
240-300	30
320-400	40
400-500	50
600-750	75
800-1000	100

Topic-4: Basic Calculation of Quantity and Cost

a. Construction Cost

The construction costs include everything that is necessary for the installation of the biodigester e.g.: excavation work, construction of the digester, the gas pipes, appliances and the construction materials. The construction cost and bill of quantities for the different sizes of the modified GGC model are given in the following table:

Table-1.5: Bill of Quantities and Cost for Biodigester Capacity 4, 6, 8 and 10 m³**

SN	Item	Unit	Unit	4m ³		6m ³		8m ³		10m ³	
			Cost**	Quantit	Total	Quantit	Total	Quantit	Total	Quantit	Total
			PKR	y	Cost	y	Cost	y	Cost	y	Cost
I Construction Materials											
1	Bricks	Nos.	3	1000.0	3000.0	1200.0	3600.0	1400.0	4200.0	1600.0	4800.0
2	Cement – 50 kg bag	bag	225	13.000	2925.0	16.000	3600.0	20.000	4500.0	23.000	5175.0
3	Gravel 1x2	m ³	1250	1.300	1625.0	1.500	1875.0	1.700	2125.0	2.000	2500.0
4	Coarse sand	m ³	1950	0.800	1560.0	0.900	1755.0	1.000	1950.0	1.100	2145.0
5	Fine sand	m ³	1950	1.100	2145.0	1.200	2340.0	1.300	2535.0	1.400	2730.0
6	Inlet PVC pipe 10cm dia, length 2m	m	250	2.000	500.0	2.000	500.0	2.000	500.0	2.000	500.0
7	Iron bars ø 8 mm	Kg	40	10.000	400.0	12.000	480.0	14.000	560.0	17.000	680.0
8	Binding wire	kg	40	0.500	20.0	0.500	20.0	0.500	20.0	0.500	20.0
9	Acrylic emulsion paint	Lit	200	1.000	200.0	1.000	200.0	1.000	200.0	1.500	300.0
Subtotal I				12375.0		14370.0		16590.0		18850.0	
II Accessories											
10	G.I Gas outlet pipe Ø 1.5", 0.6m length with elbow	pcs	450	1	450	1	450	1	450	1	450
11	GI nipple, Ø 0.5" for connecting main gas pipe and main gas valve	pcs	40	1	40	1	40	1	40	1	40
12	Main gas valve (Ball valve Ø 0.5")	pcs	200	1	200	1	200	1	200	1	200
13	Male-female socket Ø 0.5"	pcs	25	1	25	1	25	1	25	1	25
14	90° elbow	pcs	15	4	60	4	60	4	60	4	60
15	Tee socket for water drain and stove	pcs	30	2	60	1	30	1	30	1	30
16	Water drain	pcs	300	1	300	1	300	1	300	1	300
17	Gas tap	pcs	150	1	150	1	150	2	300	2	300
18	Teflon tape	pcs	30	1	30	1	30	1	30	1	30
19	GI pipe Ø 0.5"	m	85	12	1020	12	1020	12	1020	12	1020
20	Gas rubber hose pipe Ø 0.5" and 2 clamps	m	30	1	30	1	30	2	60	2	60
21	Stoves - single burner	pcs	300	1	300	1	300	2	600	2	600
22	Pressure Manometer	pcs	150	1	150	1	150	1	150	1	150
Subtotal-II				2815.0		2785.0		3265.0		3265.0	
III Labours											
23	Skilled Labour	No.	350	9	3150	10	3500	11	3850	12	4200
24	Unskilled Labour	No.	150	19	2850	22	3300	24	3600	28	4200
Subtotal III				6000		6800		7450		8400	
Total				21190.0		23955.0		27305.0		30515.0	
Overhead, Guarantee and After-sales Services (15%)					3178.5		3593.3		4095.8		4577.3
Total Cost of Installation					24368.5		27548.3		31400.8		35092.3
Cost of Installation in US\$					406.14		459.14		523.35		584.87

**** Costs given in the above table are indicative and will change according to site situations.**

b. Operation and Maintenance Cost

The operation and maintenance costs consist of wage and material cost for:

- collection and transportation of the substrate
- water supply
- feeding and operation of the plant
- supervision, maintenance and repair of the plant
- storage of the effluent

The operation cost of biodigester is virtually negligible if feeding material is not needed to be purchased. O&M cost is assumed to be 2-4% of the total cost of installation per year.

c. Financial Viability

One biodigester of 6 cum capacity costing PKR 45,000.00 to install, can produce up to 2 cum of biogas per day, which is enough to burn single burner stove for 5-6 hours. The produced biogas can replace 10 kg of firewood or 1.2 litres of kerosene or 1 kg of LPG or 4 units of electricity. The following table shows the simple calculation on the monetary value of the quantity of different fuels saved assuming the unit rates of conventional fuel sources as given in the table:

Table-1.6: Benefit – Cost Analysis

Type of Fuel Sources	Unit	Quantity saved per day	Cost per unit (PKR.)	Total cost saved per day (PKR.)	Total cost saved per year (PKR.)	Payback period without any subsidy in Years
Firewood	kgs	10	5	50	18,250	2.5
Kerosene	litre	1.2	50	60	21,900	2.1
LPG	kg	1	125	125	45,625	1.0
Electricity	units	4	8	32	11,680	3.9

It is clear from the above table that biogas has higher replacement values if it is used to replace LPG. The replacement value is relatively low for electricity. The minimum and maximum savings because of the use of biogas are PKR 11,680 for electricity and PKR 45,625 for LPG. Without any subsidy, the payback period of a 6 cum biodigester is only one year if used to replace LPG, which is financially very attractive. However, if the biogas is used to replace electricity the payback period is about 4 years.

Learning Units 12, 13, 14 and 15

Unit 12 - C4.1: Name different types of construction materials needed for constructing a fixed dome biodigester

Unit 13 - C4.2: Appraise quality standards of construction materials

Unit 14 - C4.3: Explain criteria for selection of construction site

Unit 15 - C4.4: Explain steps of construction of a fixed dome biodigester

Topic-1: Quality Standards of Construction Materials and Appliances

If the construction materials to be used for the construction of biodigester are not of good quality, the biodigester will not function properly even if the design is correct and workmanship involved in construction is excellent. The plant will never be of high quality if inferior quality of construction materials is used. In order to select these materials of best quality, required quality standards and specifications of these materials are briefly described below:

Cement

Cement should be high quality Portland cement from a brand with a good reputation. It must be fresh, free from lumps and stored in dry place. Cement with lumps should be used for construction. Bags of cement should not be stacked directly on the floor or against the walls. Wooden planks have to be placed on the floor to protect cement from dampness. Cement bags should be stalked at least 20 cm away from any walls.

Sand

Sand should be clean and should not contain soil or other materials. Dirty sand will have very negative effect on the strength of the structure. If sand contains more than 3% impurities, it must be washed. The quantity of impurities especially the mud, in the sand can be determined by a simple 'bottle test'. A small quantity of sand is put into a transparent bottle and water is poured into it. The bottle is shaken vigorously for a while. The bottle is then left stationary to allow the sand particles to settle down. The particles of sand are heavier than that of silt and clay, so it settles faster whereas the mud particles settle slower. After 30 minutes, the layer of mud versus sand inside the bottle is measured without shaking the bottle. If the depth of mud is more than 3% of the total depth, then it can be concluded that the sand contains too much mud. If this happens, the sand should be washed before use. Coarse and granular sand are best for concreting, however, fine sand has to be used for plastering works.

Gravels

Size of gravel should not be very big neither very small. It should not be bigger than 25% of the thickness of the concrete product where it is used. The smallest thickness of concrete layer in the foundation and that of outlet slabs is 7.5 cm (3"), therefore the maximum size of gravels should be 2 cm or $\frac{1}{4}$ size of the size of thickness of concrete layer. Gravel should be clean, hard and of angular shape. If it is dirty, it has to be washed properly before use.

Water

Water is mainly required for making the cement mortar for masonry works, concreting works and plastering. It is also used to soak bricks before using. Besides, it is required for cleaning or washing construction materials if they are dirty. The water from ponds or canal may be dirty so

it is better not to use it. Dirty water will have an adverse effect on the strength of structure. Water from water tap or well or any other sources that supply clean water has to be used.

Bricks/Stones

Brick plays a very important role in construction especially for GGC model of biodigesters. Bricks should be of high quality (no.1), usually the best quality available in the local market. The bricks should be well burnt, straight, regular in shape & sizes and should not have cracks or broken-parts. High quality bricks make a clear metallic sound when hitting them to each other. Such bricks should be able to bear a pressure of 120 Kg per square centimetre. Before use, bricks must be soaked for few minutes in clean water. Wet brick will not absorb water from the mortar which is needed for setting properly.

In areas where bricks are expensive and not available, stones can be used for construction of the GGC model biogas plants. Stones to be used in the construction should be best locally available. When hitting one stone with another, stones should not break. When the stone is scratched with a pointed object like iron nails, there mark should not be more than 1mm. If the stones are dirty it should be washed. Before use, stones must be soaked for few minutes in clean water.

Acrylic Emulsion Paint

It is used to make the gas holder (dome) of biodigester air-tight. Paint of this type should meet quality standard and they must be approved from concerned quality control authority.

Mild Steel Bars

MS bars are used to construct the covers of outlet tank and water drain chamber. It should meet the engineering standard generally adopted. For plants of 50, 75 and 100, MS rods of 10 and 12 mm diameter is recommended. MS bar should be free from heavy rust.

Main Gas Pipe

Gas stored in the gas holder is conveyed to the pipeline through this pipe which is placed in the topmost portion of the dome. The joint of reduction elbow with this pipe should be perfect and gas tight otherwise gas leakage from this joint cannot be stopped easily. Therefore it is recommended that the reduction elbow has to be fitted in a workshop to ensure perfect air-tightness of the joint. The gas pipe should be properly galvanized and approved by concerned quality control authority. This pipe should be made up of light quality iron and MS rod has to be welded at one end to embed it with the concrete during installation. The length of this pipe should be at least 60 cm.



Template

Template is used to ensure the right curvature of the dome while construction. It is essential to use the template to ensure right curvature of mud-shuttering required for the dome construction. The templates are different for different plant sizes.

Topic-2: Selection of Construction Site

Selection of construction sites are mainly governed by the following factors:

- The site should facilitate easy construction works.

- The selected site should be such that the construction cost is minimized.
- The selected site should ensure easy operation and maintenance activities like feeding of biodigester, use of main gas valve, composing and use of slurry, checking of gas leakage, draining condensed water from pipeline, maintain filters etc.
- The site should guarantee plant safety
- The area available should be adequate to accommodate all the units of the biodigester.

Based upon the above mentioned factors, it is recommended to select plant location based upon the following considerations. Please note that it will not be possible to meet all the requirements as stated below, however, it should be ensured that as many as possible points are considered.

- For effective functioning of biodigesters, right temperature (20-35°C) has to be maintained inside the digester. Therefore it is better to avoid damp and cool place – Sunny site is preferable.
- The area to construct plant should have even surface.
- The site should be in slightly higher elevation than the surrounding. This helps in avoiding water logging. This also ensures free flow of slurry from overflow outlet to the composting pit.
- To make plant easier to operate and avoid wastage of raw materials, especially the dung, plant must be as close as possible to the cattle shed.
- To mix dung and water considerable quantity of water is required. If water source is far, the burden of fetching water becomes more. However, the well or ground water source should be at least 10 meter away from the biodigester especially the slurry pit to avoid the ground water pollution.
- If longer gas pipe is used the cost will be increased as the conveyance system becomes costly. Furthermore, longer pipeline increases the risk of gas leakage. The main gas valve which is fitted just above the gas holder should be opened and closed before and after the use of biogas. Therefore the plant should be as near to the point of application as possible.
- The edge of plant should be at least 2 meter away from the foundation of house or any structure.
- There should be enough space for compost-pit(s) as these are integral parts of the biodigester as shown below.

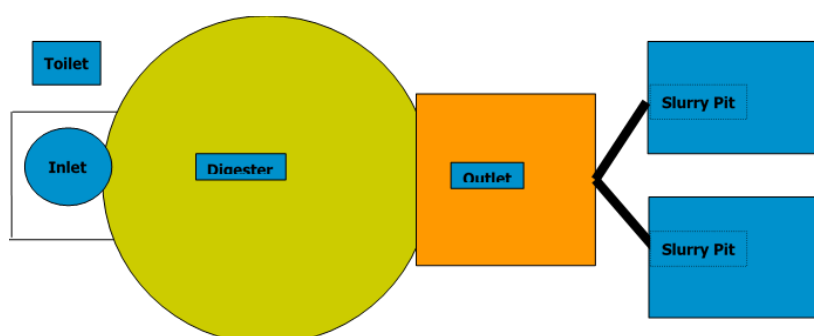

- The site should be at sufficient distance from trees to avoid damage of bio-digester from roots.
- Type of soil should have enough bearing capacity to avoid the possibility of sinking of structure.

- When space is a problem, the cattle shed can be constructed on top of the plant after proper backfilling.

As mentioned above the size of biodigester is dependent on the collectable cow dung on the farm. The required area for construction based upon the overall dimensions of the plants are mentioned below:

10 m³ plant: 6 meters x 3 meters
 20 m³ plant: 8 meters x 3.5 meters
 30 m³ plant: 10 meters x 4 meters
 40 m³ plant: 12 meter x 4.5 meters
 50 m³ Plant: 14 meters x 5 meters
 75 m³ Plant: 16 meters x 6 meters
 100 m³ Plant: 18 meters x 7 meters



The area mentioned above is the minimum area which would be required for the construction of biodigester. Some additional space will be needed for the movement of the personnel operating the biodigester. The above mentioned area also does not include the area required for bioslurry/composting pits. Ideally, the total volume of bioslurry pit should be at least equal to the size of biodigester. A minimum of two pits would be required.

Topic-3: Construction Steps

While constructing a fixed dome biodigester in farmer's premises the following activities have to be implemented in sequential order:

- Selection of correct size of biodigester
- Selection of construction site
- Collection of construction materials that meet the quality standards
- Lay-out of plant
- Digging of the pit (Excavation)
- Construction of floor/foundation
- Construction of digester walls and installation of inlet pipes
- Backfilling the empty spaces outside the digester wall
- Construction of gas holder (preparation of mould, concreting, fixing of dome gas pipe)
- Removing of mould and plastering of inside of gas holder
- Construction of manhole
- Constructing Inlet chamber/Mixing tank and mixing device
- Constructing outlet chamber and outlet covers
- Construction of turret
- Installation of pipeline, fittings and appliances
- Installation of filter systems (CO₂ scrubber, H₂S filter and moisture remover)
- Installation of pump/generators
- Testing for leakages
- Filling the plant with feeding
- Construction of slurry pit(s)
- Filling the top of dome and sides of outlet tank with earth
- Cleaning the site
- Orienting the users on simple operation and maintenance activities

Self-Assessment Questions for Participants – Module-1

The participants of the training should assess themselves at the end of the training sessions designed for this module. The following probe-questions could be used as guidance for self-assessment process:

SN	Self-Assessment Questions
1	What is biogas? How is it produced?
2	What are different types of feeding materials that can be fed into a biodigester?
3	Explain different types of biodigesters and their comparative advantages.
4	Describe various components of a fixed dome biodigesters. Explain their purposes.
5	How does a fixed dome biodigester works?
6	How do you select the size of a biodigester for a specific farm condition?
7	What do you mean by the term HRT and how does it affect the selection of size of a biodigester?
8	State the type of construction materials needed for constructing a fixed dome biodigester.
9	From a drawing of a biodigester, explain dimensions of various components of a 25 m ³ biodigester
10	Explain the steps of construction of a fixed dome biodigester in a sequential order.

Module- 02: Construct civil structural components of a fixed dome biodigester

Introduction

a. Title: Construct civil structural components of a fixed dome biodigester

b. Aim: The overall objective of this module is to ensure that the participants: (a) acquire hands-on-experiences on construction of different structural components of fixed dome biodigesters, and (b) realise the importance of quality assurance, and practice quality norms while construction.

c. Duration: Total – 112 hours; Theory – 8 hours; Practice – 104 hours

d. Competency Standards

The following competency standard is covered under the framework of this module:

- i. Standard 5: Construct structural components of a fixed dome biodigester
- ii. Standard 8: Practice quality norms and ensure the compliance of quality standards while construction

e. Learning Outcomes

After completion of this module the trainees will be able to:

- | |
|---|
| <ol style="list-style-type: none">1. Construct digester2. Construct gas holder and turret3. Construct manhole, outlet/ hydraulic chamber4. Construct inlet and mixing tank5. Construct slurry collection and composting pit6. Describe the importance of quality assurance7. Practice quality norms during construction8. Describe the roles and responsibilities of a biogas technician9. Practice occupational health and safety measures |
|---|

f. Formative / sessional assessment at the end of the module

The following are the most appropriate assessment methods to gather evidence to evaluate the learning of participants for this particular module.

- direct observation, for example:
 - observation of the performance during on-the-job training
- structured activities, for example:
 - simulation exercises/role-plays for assessing understanding occupational health and safety during work
- questioning, for example:
 - interviews
 - self-assessment
 - verbal questioning
 - oral examinations
- portfolios, for example:
 - collections of work samples compiled by the candidate
 - product with supporting documentation
 - historical evidence
 - information about life experience
- review of products, for example:

- products during on-the-job exercise
- work samples/products
- third party feedback, for example:
 - testimonials/reports from employers/supervisors
 - evidence of training
 - authenticated prior achievements
 - interview with employer, supervisor, peer

The following assessment instruments - the documented questions/assessment activities developed to support the selected assessment method/s used to collect the evidence of candidate competence could therefore be used:

- oral questions
- observation/demonstration checklists
- candidate self-assessment guides
- recognition portfolios/workplace portfolios
- simulation activities
- definition of relevant workplace documents
- evidence/observation checklists
- checklists for the evaluation of work samples

The following table summarises learning units for this module and formative assessment guidelines:

LEARNING UNIT	FORMATIVE ASSESSMENT	SCHEDULED DATES	
C5.1: Construct digester C5.2: Construct gas holder and turret C5.3: Construct manhole, outlet/hydraulic chamber C5.4: Construct inlet and mixing tank C5.5: Construct slurry collection and composting pit C8.1: Describe the importance of quality assurance C8.2: Practice quality norms during construction C8.3: Describe the roles and responsibilities of a biogas technician C8.4: Practice occupational health and safety measures	a. What do you understand by the term 'lay-out'? b. What are critical factors that need to be considered during the construction of digester? c. How many plaster coats are necessary to make the gas holder air-tight? d. What is the common cement sand ratio for normal plastering of outlet and inlet walls? e. Describe the benefits of compost pits. f. Describe the role of a mason for ensuring quality. g. What are some of the important occupational health and safety measures needed to be followed while construction?		

Outline of Learning Units for Module-2

Learning Units 1, 2, 3, 4 and 5

Unit 1 - C5.1: Construct digester

Unit 2 - C5.2: Construct gas holder and turret

Unit 3 - C5.3: Construct manhole, outlet/ hydraulic chamber

Unit 4 - C5.4: Construct inlet and mixing tank

Unit 5 - C5.5: Construct slurry collection and composting pit

Topic-1: Layout and Construction of Digester

The process of biogas production is a dynamic system - when gas is produced inside the pit, the gas pressure will push manure and slurry at the bottom of the pit to flow up into expansion chamber. When this gas is used, the slurry in the expansion chamber will flow back into the digester chamber to push the gas up for usage. This happens consistently. The plant will be operated efficiently for a long period of time if the digester and dome does not crack and the system runs regularly. In each case the strength of the plant depends on fine construction, specification of materials according to the criteria suggested by the Biogas Program, and strict adherence to the construction manual. The drawing below shows the structural components of a fixed dome biodigester:

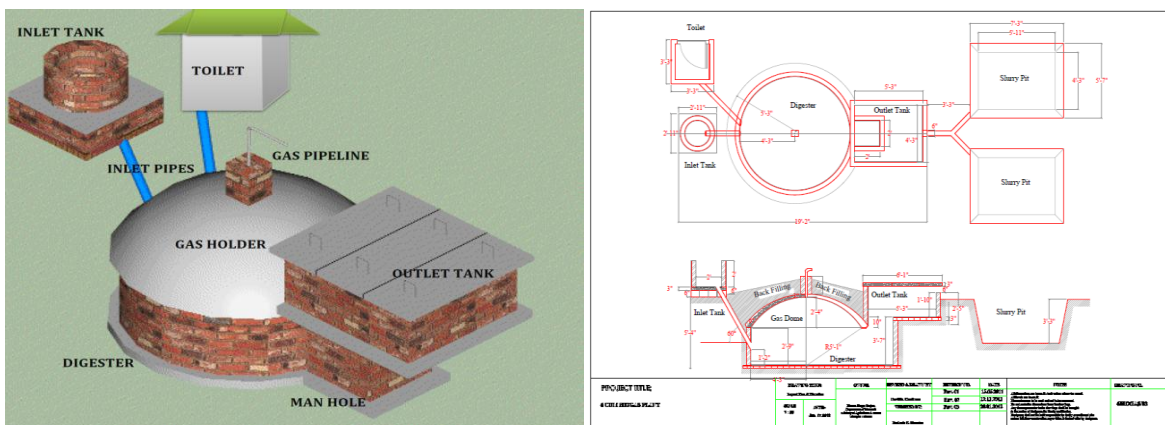

The methods of construction of structural components of the above shown biodigester have been described in the following sections:

1.1. Layout Works

Construction works of biodigester starts with the process of layout works. This is the activity carried out to mark the dimensions of plant in the ground to start the digging work. For this purpose, first an imaginary line that connects the centres of inlet pipe, digester, manhole and outlet has to be fixed. Then a small peg has to be stuck in the ground at the centre spot of the digester. The following steps should be followed:

- Calculate the tentative length and breadth of the space required for the construction of biodigester as per the available drawings.
- Level the ground and determine the locations of the digester, outlet tank and inlet pit and draw a straight line in which the centres of inlet, digester and outlet will be located (generally referred as hart-line). Mark with white powder on the centre line for inlet, digester, outlet and compost pits on the ground so that all are accommodated in the same plane.

- Decide the reference level. Fix two wooden pegs 2 m away from the end points of the plant as reference points during the construction. It is better to assume the levelled ground level as the reference level. The top of the dome (outer) should exactly be in this level.
- Insert sticks or wooden pegs in the hart-line to mark the centres of the two spherical portions (in the sides) and central cylindrical portion of the proposed digester pit. Select the outer radius of the pit (digester diameter plus wall thickness plus plaster thickness plus space for a footing projection of at least 10 cm) for brick walls as shown in the drawing and mark it in the rope or chord. For stone masonry, this 10 cm will also be used as the wall thickness as stone wall could not be constructed with 10 cm thickness. With the help of this peg and chord prepared earlier, make a circle, which indicates the area to dig.
- Preferably the inlet of the digester should not be located more than 5 meters away from the enclosure/cattle shed.
- Ensure that the bioslurry from the outlet/expansion chamber flow into the farmer's field or the slurry pit/composting pit and NOT into natural water bodies such as rivers to be avoid the risk of pollution.

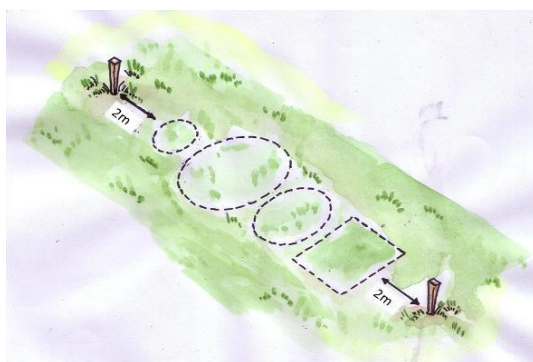

1.2. Excavation of Pit

- After the layout work is done, excavation for the digester is started.
- During the excavation, the pit wall should be as vertical as possible.
- The excavated soil should be placed at least 1 meter away from the pit so that the soil does not fall in the pit during the excavation and to avoid possible collapse of the pit wall due to its self-weight.
- If loose soil is confronted during the excavation, earth protection works will be required to hold it in position.
- When underground water is encountered, another pit close to it is prepared so that the water



flows down in this pit, from where the collected water can be drained out.

- The excavation is done up to the depth as shown in the drawing. If the depth of excavation is more than that in the drawing, avoid refilling the pit with soil and construct the foundation of the biodigester in the natural untouched soil.
- For the excavation of the digester bottom, first of all, locate the inner wall position by deducting the offset width and wall thickness. Measure the distance from the inner wall towards the centre of the digester and mark a point. Excavate up to a depth of as shown in the drawing including the thickness of PCC and Stone soling.



Note: If ground water of large stone/boulders is encountered in the pit during the excavation, the technical person at the site will give the final advice for further course of action.

1.3 Construction of Floor/Foundation of Digester

- Prepare the bottom surface/floor of the digester by gently patting and properly levelling it.
- Fix a straight iron rod or GI pipe in vertical position at the centre of the digester. Choose the length that is enough to cover the top of the digester dome
- Select the diameter of the iron rod or the GI pipe sufficient enough to keep the rod straight when fixed on the ground.
- Place a horizontal pole or a pipe across the pit edges so that the vertical rod or pipe can be secured with it properly.
- Check the verticality of the rod or pipe when secured with the horizontal pipe using a plumb bob.
- Correct any deviation found to make the rod or pipe vertical.
- Constructed base of stone or brick soling of required thickness above the levelled surface. The stone boulders or bricks should be placed as closely as possible.
- Ram the soling layer with a rammer and compact it.
- Select the proper size of the rebar as required if RCC is needed in case the bearing capacity of the soil is low.
- Clean, straighten, cut and bend the rebar as per the requirement.
- Place reinforcement steel bars on the stone surface and bind them with steel binding wires.
- Mix cement, sand and aggregate in the ratio of cement 1: sand 2: aggregate 4 (1:2:4) on a clean dry surface.
- Add water gradually in it to make a uniform concrete mix. The content of water shall not exceed 50% of the cement quantity used for the mix.
- Pour the concrete gently on the stone/brick surface to make the required thickness as shown in the drawing.
- Pull the vertical rod or pipe immediately after the concreting works so that the bottom end of the rod or pipe touches the finished concrete surface avoiding the fixing of rod or pipe in the concrete.
- Cover the concrete surface with plastic sheet for the night to avoid any damage by the rain.

- Remove the plastic sheet on the following day and cover with used jute bags.
- Sprinkle water 4-5 times a day for 3 days on the jute bags to keep it wet.
- The concrete is allowed to set for 3 days before any work on it could be started.



1.4 Construction of Digester Walls

OPTION A: BRICK WALL

- Soak the brick/stone in water for about 10-15 minutes before use.
- Prepare mortar for brick/stone wall construction in the ratio of 1 part cement to 3 parts sand.
- The vertical pipe placed while constructing the floor, has again to be checked whether it is still in the right position. Now, fix the radius of wall at the finished floor with the help of a string or chord attached to the vertical pole or pipe. The length of this string or chord can be found on the drawing. Plaster thickness (1.5 to 2 cm) has to be added to this length to allow space for plastering. Every brick or stone which is laid in the round-wall has to be exactly at a distance of (radius+plaster thickness) from the vertical pipe. After deciding the radius of digester, a circle has to be drawn to decide the inner circumference of the round wall. Now, the base of round wall (the collar) is constructed. The collar is a thick layer of mortar 2.5-3 cm placed on the untouched earth in the floor of the excavated pit along the circle. The construction of round wall should be started from the side of manhole. First a space of 60 cm plus plaster thickness has to be marked and then construction of wall started. Place the first brick/stone with the help of guiding string. Go on placing the bricks/stones in circle with the help of this string. Construct the wall from one direction only, either clockwise or counter clockwise.
- The face of wall should be maintained inside while constructing the wall. If brick masonry, the first row of bricks must be positioned on their sides so that a **5 cm** high, **25 cm** wide base is made. For smaller than 10 m³ capacity plants, the next rows of bricks can be positioned on their lengths so that the wall thickness becomes 4.5". However for plants larger than 10 m³, the thickness of the wall should be one brick (25 cm).





- It is not necessary to make pillars in the wall but the backfilling between wall and pit-side must be compacted with great care. This backfilling has to be done in the morning before starting the construction work. Earth should be well compacted by adding water and gentle ramming all along the circumference of the digester. Poor compaction will lead to cracks in round-wall and dome.
- If stone is used for the construction of round wall, the wall should rest against the pit-side as it is difficult to have proper backfilling because of the irregular shape of the outside of the stone wall. The cement mortar used can be 1 cement-3 sand to 1 cement-4 sand depending on the quality of the sand.
- While laying bricks/stones ensure that the space (joints) between them is filled with mortar, properly compacted. The thickness of mortar joint should at least be 10 mm. However it should not exceed 15 mm. Ensure that the mortar joints in two adjacent brick layer never fall in vertical line.
- When the height of round wall reaches 30 cm (for 4 and 6 cum plants) and 35 cm (for 8 and 10 cum plants), place 2 inlet pipes (one for conveying cattle dung and the other for human excreta from toilet). These pipes should drain exactly at the opposite side of the manhole opening. The slope of these pipes should at least be 60° with the ground level. Ensure that the lengths of inlet pipes are sufficient enough to construct the floor of inlet at least 15 cm in higher elevation than the level of slurry overflow at the outlet wall. To reduce the risk of blockages, the inlet pipe(s) must be placed as vertically as practically possible.
- The height of the round-wall measured from the finished floor can be found on the drawing. The construction of round wall should be continued till the height is height+floor thickness which is usually 7-10 cm. If the foundation is constructed before the round wall, the height of round wall should be equal to that shown in drawing.
- Exactly to the opposite of the dung inlet pipe, a 60 cm wide opening must be left in the round-wall which acts as manhole. The digested slurry also flows out to the outlet tank through this opening. The inlet pipe from the latrine should be placed as close as possible with the dung inlet pipe with a maximum distance of 30 degrees from central line (hart line).



- Ensure that the thickness of cement mortar in between each layer of brick wall is 10 mm. The brick joint gap for cement mortar should be in the range of 10-15 mm.
- Ensure that the brick joints of first layer and the second layer never fall in a vertical line.
- Check the verticality of the wall with a plumb bob for each layer of the brick wall during the laying of bricks.
- Place and fit the inlet pipe (feeding pipe) of 150 mm to 200 mm diameter in the position when the round-wall is 35 cm high. Ensure that the inlet pipe discharges exactly to the opposite side of manhole to avoid short-circuiting or bacteria wash-out.



OPTION B: RCC WALL

- Select the proper size of the rebar as required.
- Clean, straighten, cut and bend the rebar as per the requirement.
- Bind the vertical rebar with the floor rebar placed above the stone surface.
- Join horizontal rebar with the vertical rebar by using steel binding wires.
- Concrete the digester floor first.
- Select suitable size of the timber for formwork.
- Erect these timber members on both sides of the rebar providing space as required.
- Provide adequate bracing to the timber members on both sides to keep the frame vertical.
- Mix cement, sand and aggregate in the ratio of cement 1: sand 2: aggregate 4 (1:2:4) on a clean dry surface.
- Add water gradually to it to make a uniform concrete mix. The content of water shall not exceed 50% of the cement quantity used for the mix.
- Pour the mix in to the frame and tamping with a metal rod is applied for proper compaction by avoiding any formation of voids in the concrete.
- Complete the concreting up to the height of 1m/day.
- Remove the frame after 3 days.
- Cover the top of the wall by used jute bags.
- Soak the jute bags with water at least 4-5 times a day for put them in walls for 7 days. Sprinkle water on the walls as many times as the jute bags are soaked.

Points to consider

- The inclination of the inlet pipe should be more than 60 degrees.

- The inlet pipe should be at the centre line of the inlet chamber as shown in the drawing.
- The toilet inlet pipe can be on either side of the dung inlet pipe as shown in the drawing.
- The inlet chamber and the toilet pipes shall be laid close to digester chamber so that the inlet pipes have adequate slope to avoid any blockages in the pipes.
- Exactly on the opposite of the inlet pipe, an opening of width 80 to 100 cm is left in the round wall which acts as a manhole.
- Select the proper size of the rebar as required.
- Clean, straighten, cut and bend the rebar as per the requirement.
- Prepare a wooden frame as per the size of the beam.
- Spread a plastic sheet on a flat surface.
- Mix cement, sand and aggregate in the ratio of cement 1: sand 2: aggregate 4 (1:2:4) on a clean dry surface.
- Add water gradually to it to make a uniform concrete mix. The content of water shall not exceed 50% of the cement quantity used for the mix.
- Pour the mix into the frame and allow it to set for 3 days.
- Carry the slab to place on the brick opening or concrete opening.
- When the round-wall has reached the correct height, the inside wall is plastered with cement mortar of 1:4 ratio.
- The brick wall should be sprinkled with water before plastering.
- The RCC wall requires light chipping before plastering.
- Mix cement and sand in the ratio of cement 1: sand 4 (1:4) on a clean dry surface.
- Add water slowly in it to make a uniform cement mortar. The content of water shall not exceed 50% of the cement quantity used for the mix.
- 12.5 mm thickness plaster is applied on the inner wall of the digester.
- The plastered walls should be sprinkled with water 4-5 times a day for curing after 24 hours of plastering.

Topic-2: Construction of Gas Holder

a. Concreting

Gas holder is the most critical component of a fixed dome biodigester which is constructed after the completion of digester. Special care should be provided to construct it as per the set quality norms. The following steps should be followed while constructing concrete gas holder:

- When the construction works of round wall as described above, is completed than the spherical (dome-shaped) gas holder has to be constructed. The gas holder is constructed with plain cement concrete (PCC) for plants smaller than 20 m³ and with Reinforced Cement Concrete (RCC) for plants bigger than 20 m³ with the help of an earthen mould prepared by filling excavated earth.
- Before filling the pit with earth to make the mould for the dome, backside of the round wall should be filled with proper compacted earth-back-filling. If this is not done, the pressure of the earth for the mould can lead to cracks in the round-wall.
- On the vertical centre pipe which is used for constructing round wall, a mark has to be made at a distance equal to height of round wall + height of dome plus 2.5 cm (the thickness of inside plastering coats), as given in the drawing, from the finished floor.

- Now soil has to be filled in the finished digester up to the marked height. Once the earth filling is completed, the vertical pipe can be removed by pulling it upwards. It has to be replaced by a shorter 0.5" dia. pipe, approx. 1 metre length, in the earth exactly at the same spot.



- Now a metallic template should be used to make the shape of the dome. The top of the round wall must be clean when the template is in use. The template can be checked by making sure the top is horizontal and the side exactly vertical.

Furthermore, the part of the template that touches the round-wall must be in the same position all over the round wall. It is important that the earthen mould is well compacted. If the earth is further compressed after casting the dome, by its own weight and that of the concrete, it can lead to cracks in the dome. The earth used for the mould has to be damp to prevent dry earth from soaking up water from freshly casted concrete.



- When the earth mould has the exact shape of the template, a thin layer of fine sand has to be spread on the mould-top by gently patting it on the surface. Any excess sand or soil that falls on the round-wall has to be removed.

- Before starting the casting work enough manpower and construction materials like sand, gravel, cement and water has to be collected on the site. The casting has to be done as quickly as possible and without interruptions in between. Such interruption will negatively affect the quality of the cast. A constant, adequate supply of concrete (mix: 1 cement, 2 sand, 3 gravel) must be made for the mason. No concrete older than 30 minutes should be used. The top of the wall has to be applied with cement-water slurry before starting the concreting work.



- The concreting of dome should be started from the top of manhole where a 15 cm thick beam has to be casted to accommodate the foundation for the outlet wall. Special care should be taken to maintain the thickness of dome while casting, i.e. the thickness in and near the edges should be more than the thickness in the centre. For 4 and 6 m³ plants, the thickness in the edge should be 15 cm whereas the thickness in the centre should be 7 cm. Similarly, for 8 & 10 m³ plants, the thickness in the edge should be 20 cm whereas the thickness in the centre should be 7 cm.

For 15 & 20 m³ plants, the thickness in the centre should be 8 & 9 cm respectively and the thickness in the age should be 25 cm.

- For plants bigger than 20 m³ RCC dome has to be constructed and the thickness of dome should be at least 15 cm in the bottom and 10 cm in the top.
- To prepare for the Reinforce Cement Concrete (RCC) Work, place the rebar on the brick wall for the round beam. Similarly, place the rebar on the plastic sheet placed on the mould top.
- First, complete the concreting of the ring beam.
- The thickness of the ring will be 10 cm and the width equal to the breadth of brick wall.
- The casting has to be done as quickly as possible and without interruptions as this will affect the quality of the cast. No concrete older than 30 minutes should be used.
- The concreting for the dome will start from the bottom and progress in a circular direction towards the top.
- Under no circumstance should the concreting of dome be done part wise from bottom to top.
- Take a sharp pointed metallic rod to measure the concrete thickness.
- Measure the wet length of the rod with a measuring tape and confirm with the required thickness.
- The concreting of dome can also be done by using metallic templates connected with each other by locking arrangements. No earth mould is required in this process. Alternatively, wooden framework could also be prepared to facilitate concreting.
- Concrete blocks of size 60mmX60mmX 60mm of PCC 1:1.5:3 are prepared and are bind with the dome rebar at multiple places to maintain uniform cover of 60 mm before the concreting.
- Cover the dome top with a plastic sheet for a night immediately after the concreting works is over to protect the surface damage by possible rain.
- Cover the dome surface with used jute bags as it is not possible to retain water on the dome surface for curing.
- Sprinkle water 4 to 5 times or even more depending upon the weather condition from the day after the casting onwards to keep the jute bags wet for curing the concrete. This process is carried for at least 7 days depending upon the climate of the plant location.
- After 3 weeks of dome casting, the earth used for mould preparation is gradually removed from the pit through the outlet of the digester provided in the ring wall.
- When all earth and the plastic sheet are removed from the dome, the dome inner wall is thoroughly brushed and cleaned with water.
- Check carefully for any pores on the concrete surface.
- Any pore on the surface will add the risk of biogas leakage and make the gas holder useless.



- If the gas comes in contact with the steel rebar, it can cause rusting and weaken its strength.
- The clear cover for rebar shall be at least 25 mm from bottom layer of upper dome so as to avoid chemical reaction with rebar.
- The small pipe on the top of the mould must be left in place till the main gas pipe is installed. This is to make sure that the main gas pipe is exactly in the centre.
- Already during the casting, the concrete has to be protected against strong sun-light by covering it with jute bags or straw mats. This protection has to be left in place for at least one week. Also from the day after the casting onwards, the dome has to be sprinkled with water 3 to 4 times a day which is known as curing.

b. Inside Plastering of Gas Holder

Gas-tightness of the gas-holder is very important for the effective functioning of any biodigester. If the gas stored in the gas-holder escapes through the minute pores, the users will not be able to get gas at the point of application. The whole investment will therefore be wasted if gas holder is not made perfectly gas-tight.

After approximately one week, depending on the temperature the earth of the mould can be removed through the manhole. When all earth is removed, the surface of the gas holder has to be cleaned with scrubbing with water and iron brush. The entire surface of the concrete dome has to be cleaned before starting the plastering. After cleaning, the following layers of plastering works have to be applied to make the gas holder perfectly gas-tight.

- Scrubbing and scratching (chiselling)
- 5 layers of dome treatment works:
 - Layer-1: Plain cement-water flush (1 part cement and 5 parts of water), applied with the help of broom
 - Layer-2: 10 mm thick plastering with cement sand mortar (1 part of cement and 3 parts of sand) applied with plastering trowel
 - Layer-3: 3 to 5 mm thick cement-sand punning (1part of cement and 2 parts of sand) with plastering trowel
 - Layer-4: Plastering with cement and acrylic emulsion paint mix (1 part paint and 10 parts cement) 3 to 5 mm thick applied with plastering trowel
 - Layer-5: Painting with thick layer of cement- acrylic emulsion paint (1 part of paint and two parts of cement) applied with painting brush (10 cm wide)

A plaster coat must be well set before applying the next layer. Interval of one day for the third and fourth coat is good for gas-tightness. While applying the plaster layers, the work must be executed with the greatest care and without interruption in between. Each layer has to be smooth and fine. Curing has to be properly done in each surface before applying another layer. The well-functioning of the plant is very much depending upon the gas tightness of the dome and hence, the work of plastering each layer has to be done very carefully and as per the set quality standards.



- Execute the plaster work with the greatest care and without interruptions. The well-functioning of the plant is very much depending on the gas tightness of dome.
- Prepare for the turret construction. Clean the top surface of the dome with metal brush and spray water on it so that all the dirt is removed. Construct a turret of suitable size with brick or PCC.
- Provide earthen backfilling around the dome with the excavated soil. Compaction at regular depth is provided.
- Proper and adequate measures have to be adopted for the workers while working inside the digester as proper ventilation is not available.



Topic-3: Construction of Manhole, Inlet and Outlet Chambers

Inlet and outlet chambers are integral parts of a fixed dome biodigester and they need to be constructed as per set quality norms and standards.

3.1. Construction of Manhole and Outlet/Displacement Chamber

- Construct manhole or outlet passage once the earthen or other type of mould/framework is removed. Manhole can be sloping or vertical. Slopping manhole facilitate clearing of scum layer if any, however it is complicated to construct.
- Ensure that the outlet tank is constructed on a slightly higher elevation than the surroundings so that there are no chances of rain water entering the outlet chamber during the rainy season.
- Outlet tank can be circular or rectangular in shape.
- For circular outlet, take a cord of length equal to the radius of the outlet chamber plus the wall thickness and the plaster.

- Mark and fix with a wooden peg on the centre line of the outlet chamber at a distance equal to the cord length by holding one end of the cord.
- Attach one end of this cord on the peg and holding tight the other end move in a circular path. Mark the circular path with a white powder.
- Excavate up to a depth (as shown in the drawing) from the ground level.
- Place the excavated earth safe from the pit edge so that the pit wall does not collapse with its self-weight
- Measure specified distance from the outer wall of the discharge outlet towards the centre of the outlet chamber and mark a point. Excavate up to a depth as given in the drawing including the thickness of PCC and Stone soling.
- Measure the required length from the outer wall of the discharge outlet towards the centre of the outlet chamber and mark a point. No excavation is required indicating the point where the outlet discharge ramp ends.
- The outlet ramp is gently patted and levelled properly.
- Stone soling of required thickness is laid on the ramp of the outlet chamber. Place the boulders as close as possible
- Mix cement, sand and aggregate in the ratio of Cement 1: sand 2: aggregate 4 on a clean dry surface.



- Add water gradually to it to make a uniform concrete mix. The quantity of water for mixing will be equal to 50% of the cement quantity used for the mix.
- Pour the concrete mix of 7.5 cm thickness above the stone soling.
- Brick work on the 2 ends of the outlet ramp is started.
- Backfill and compact the space behind the ramp wall properly.
- Stone soling of required thickness is done in the remaining part of discharge chamber. Place the stones as close as possible.
- Plain Cement Concrete (PCC) work is started.
- Pour the concrete mix on the stone soling and make a PCC of thickness 7.5 cm.
- This PCC will cover the top surface of the 2 brick walls.
- Sprinkle water 4 to 5 times a day at least for 3 days on the finished PCC surface the following day for the curing.
- Brick work for the walls of outlet is then started.
- Construct the wall till the required height is reached.
- Provide overflow opening on the top of the brick wall exactly in opposite direction to the manhole for the discharge of digested bioslurry to the compost pit.
- The size of the opening will be at least 40 cm high and 30 cm wide.
- Select the proper size of the timber and prepare 2 form works for the casting of 2 beams.

- The length of the formwork will be equivalent to the internal diameter of the discharge chamber.
- Fix the formwork with adequate props from below to support the weight of the frame and the self-weight of the rebar and the concrete.
- The opening of the formwork shall be equal to the width and height of the beam.
- The props can be locally available bamboos.
- Reinforce Cement Concrete (RCC) work is started.
- Place these rebar in the frame and bind them with steel binding wires. (refer to the prototype drawing)
- Pour the mix in the frame from one end of the form work.
- Take a 2 feet metal rod and tamp the concrete in the frame for a proper compaction and eliminate the possibility of void formation in the concrete.
- Cover the beam with used jute bags and sprinkle it with water from the next day.
- Sprinkle water 4 to 5 times a day for at least 5 days for curing.
- Before the cement plaster work is started, sprinkle clean water on all the brick surfaces.
- Cement plaster work is started.
- The formwork for the casting of the beams is removed after 3 weeks.
- Clean the beam surface and apply light chipping on it for plaster work.
- Cement plaster work is started. (refer to Annex)
- Sprinkle water for 4-5 times a day for 5 days on all the plaster surfaces for curing.
- Prepare a flat and clean surface for the casting of chamber covers close to the chamber so that it can be carried to the chamber location without difficulty.
- Spread a thin sheet of plastic over this surface to cover the entire cover area of the slabs.
- Make 9 pieces for the cover slabs.
- Select the proper size of the rebar as required.
- Reinforce Cement Concrete (RCC) is started.
- Place these rebar in the frames and bind them with the binding wires.
- Pour the mix properly in the frames separately and pat the concrete surface gently so that the compaction avoids any formation of voids in the concrete.
- The thickness of the concrete slab will be 10 cm.
- Cover the frames with a plastic sheet for the night and avoid any damage by the rains.
- Sprinkle water on the slab surfaces with water 4 to 5 times a day for 7 days for curing.
- Dislodge the frames from the casted slabs.
- Lift the cover slabs to remove the plastic sheets.
- Check both the surfaces of the slabs. Any exposure of rebar is exposed to corrosion by the fumes produced in the chamber. In that case, proper cement plaster should be applied on both sides of the slabs.



3.2. Construction of Inlet/Mixing Tank

- The inlet pit is constructed to mix required quantity of animal dung and water.
- The layout of this unit is governed by the slope of the inlet pipe joined to the digester.



- The inclination of the inlet pipe more than 60 degrees.
- This pipe will emerge out of the ground on centre line of the plant.
- The inlet pipe level should be 15 cm above the discharge outlet level.
- Inlet can be circular or rectangular depending upon the type of mixing device.
- Level the ground and complete the layout.
- Take a cord of length 12 m and put an ink mark at 3 and 7 m.
- First person will hold both the ends of the cord and the second person will hold the 3 m mark.
- The second person will place the 3 m mark on the 1m point on the centre line of the pit and the third person while holding the 7 m mark will pull the string from the first person and place it on the ground in such a way that the sides of the triangle formed are 3, 4 and 5 m.
- Mark the new location where the 7 m mark touches the ground.

- Similar procedure is followed in the opposite side of the pit.
- This procedure will help to keep the walls at 90 degrees to the centre line.
- Follow the same procedures at the 3 corners.
- Excavate up to a depth of 10 cm from the ground level.
- Stone is laid on the excavated surface for a thickness of at least 15 cm.
- Place the stone boulders as closely as possible.
- Plain Cement Concrete (PCC) work is started.
- Pour the concrete on the stone soling for a thickness of 7.5 cm.
- Construct the brick walls.
- Fix the mixture accessories/mixing device in the inlet chamber. Mixing device can be horizontal or vertical.
- Plaster the inner and outer surfaces with 1:3-1:4 cement mortar.
- The following picture illustrates the fixation of mixing device:

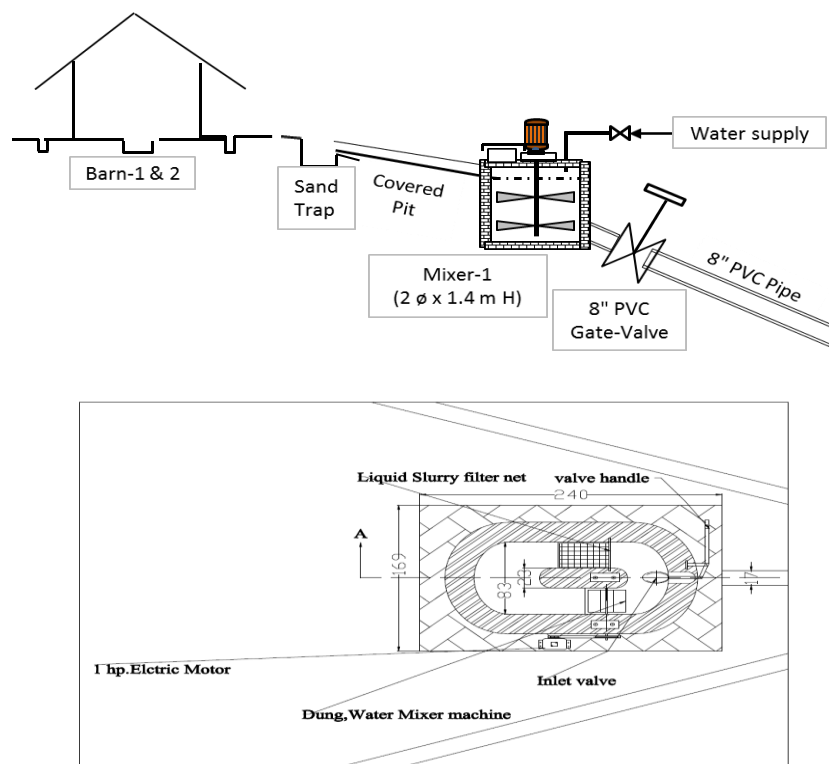

Fig: Installation of Mixing Device

Note: In case of toilet attachment to the plant it is better to construct without siphon or trap as the pan with siphon needs more water which may result excess water inside the digester. It is also not possible to de-block the pipe when the toilet has a trap. The toilet should not be farther than 45 degree from the centre line. Additionally, the toilet pan level should be at least 15 cm above the outlet overflow level.

Topic-4: Construction of Slurry Collection Pit and Backfilling

- The pits are located close to the outlet overflow so that the waste slurry runs freely into the pits.
- The distance between the outlet chamber and the pit is maintained at 1m apart.
- The size of the compost pits shall have a capacity equal to the plant volume.
- Prepare for the layout of the compost pits
- Refer previous marked reference points. Mark on the centre line of pits at a distance of 1 m.

- Take a cord of length 12 m and put an ink mark at 3 and 7 m.
- First person will hold both the ends of the cord and the second person will hold the 3 m mark.
- The second person will place the 3 m mark on the 1m point on the centre line of the pits and the third person while holding the 7 m mark will pull the string from the first person and place it on the ground in such a way that the sides of the triangle formed are 3, 4 and 5 m.
- Mark the new location where the 7 m mark touches the ground.
- Similar procedure is followed in the opposite side of the pit.
- This procedure will help to keep the walls at 90 degrees to the centre line.
- Follow the same procedures at the 3 corners of each pit.
- The length and the breadth of the pit walls are marked as per the dimensions.
- White powder is used for the lay out.
- Excavate the pit up to a depth of 1 m.
- Immerse bricks in a clean water tank for at least 1 hour for proper soaking.
- Brick work is carried out.
- The discharge outlet channel is bifurcated in 2 which are joined to 2 separate pits.
- The inclination of the 2 bifurcated channels shall be 90 degrees.
- Cement plaster work is then done.
- Provide fencing across the pits to protect children from injury.
- Local available materials can be used for the fencing.
- Length and width of the pit can be changed according to the space available without changing the volume of the pits.
- If possible it is better to adopt length: breadth ratio to be 1.5 to 2.
- Depth of the pit should not exceed 1 meter (100 cm) due to safety reason.



Once the construction of all the structural components are complete, the biodigester need to be backfilled properly to insulate it properly to minimize any temperature fluctuation inside the digester, especially during the winter months.



Learning Units 6, 7, 8 and 9

Unit 6 - C8.1: Describe the importance of quality assurance

Unit 7 - C8.2: Practice quality norms during construction

Unit 8 - C8.3: Describe the roles and responsibilities of a biogas technician

Unit 9 - C8.4: Practice occupational health and safety measures

Topic-1: Importance of Quality Assurance

1.1. Rational

Non-functioning and poorly functioning biodigesters cause not only capital waste but also do a lot of harms and damages to the reputation of biodigester technology and eventually to the desired future expansion of biodigester program. To safeguard the interest of the users, implementing agencies and donors, it is important that the biodigesters function to the desired level; which is only possible when the plants are selected, constructed and operated as per the set quality standards. To ensure the quality of biodigesters, it is important that effective quality control mechanisms are formulated and enforced efficiently. The quality on training and capacity building; promotion and extension activities; construction, operation and maintenance of biodigesters have to be a major concern. There is need to ensure each and every biodigesters installed functions as anticipated. Non-functioning biogas plant will pose negative effect at different levels as follows:

(a) At Client's level

- Sub-standard quality of product leading to unsatisfied clients,
- Gossip/negative image,
- Loss of investment,
- Waste of land and initiative

(b) At Mason's/constructor's level

- Bad reputation
- Loosing of job,
- No growth
- Loss of investment

(c) At Program's level

- Waste of resources
- Loss of momentum/
- Slowdown of distribution
- Set back of the program
- Drop out of donors
- Ultimate failure of Program

Quality control is increasingly important concern during biogas program implementation. Defects or failures in constructed biogas plants can result in costs. Even with minor defects, re-construction may be required and facility operations impaired. Increased costs and delays are the results. The structured QC system is therefore important for the following main reasons:

- a. To maximize performance, reliability and lifetime of every biogas plant
- b. To maximize the value for money for Biogas customers, donors and the Government
- c. To maximize the potential livelihood benefits to customers and communities
- d. To minimize the risk of accidents or damage to users or property

- e. To maintain the reputation, credibility and value of the Biogas Program in Pakistan

Quality standards are developed to facilitate the work of quality control. Quality standard is a framework for achieving a recognized level of excellence within the program. Achievement of a quality standard demonstrates that the program activities have met the requirements laid out by a quality control authority. In general, quality standards are the benchmarks of levels of service or design specification.

To facilitate effective monitoring for ensuring quality, standards have been developed under. The quality standards are basically related to the following aspects:

- a. Quality standards related to location and size of biodigesters
- b. Quality standards related to the design of biodigesters
- c. Quality standards related to construction of structural parts and installation of pipes, fittings are appliances.
- d. Quality standards for the operation and maintenance of biodigesters (after-sale-services on behalf of the installers and routine O&M on behalf of users)

1.2 Quality Control Process

Any biogas program should realize that Quality Control of the Project Implementation in respect of construction is the key factor in the success and scaling up of the intervention. The Quality Control Mechanism is usually divided in 3 levels:

Level 1: Quality at level 1 deals with the quality of preparations made for the plant construction. It is to ensure that the masons and the supervisors of the Biogas Construction Companies (BCCs) are well trained planning, layout, construction and operation of the biogas plants in accordance with the available cow dung on the farm. They should also be well trained in the selection of proper construction material, construction process and selection of fittings/accessories to be used on the site. The biodigesters should be constructed in accordance with the construction details, the measurement/ specifications and procedures detailed in the construction manual.

Level 2: Level 2 inspection deals with quality of plant construction and its adherence to the plant design. Quality Control Companies (QCCs) will be engaged to keep a check on the BCCs as specified below at 3 stages of construction. Trained quality inspector from the QCCs shall visit the plant construction site at predefined construction stages, complete the Quality Inspection Forms and submit to the QC authorities. In case of deviation from the designed dimensions the construction work will continue only after clearance by the concerned authority. Level 2 inspection is divided in a number of stages as described below.

Stage 1: This inspection shall be conducted after digging of the digester pit and prior to laying the digester floor. The inspection will include taking of measurements of the excavation prior to pouring of the plant floor and the inspection of floor pouring exercise to ensure the use of correct concrete mixture and other material being used.

Stage 2: Second inspection will be conducted prior to mud shuttering of the Plant Dome. BCC shall inform QC authority and the BCC about this date well in advance. The inspection will include checking of digester dimensions and the Beam on the manhole and dome foundation.

Stage 3: This will be carried out on the day when the digester has been filled with mud and the dome shuttering has been made with the help of dome template. This will be on the day when

dome is to be casted. The QC inspector will check the mud shuttering with the help of template, witness the dome casting, guide and report the dome casting procedure followed by the BCC.

Stage 4 inspection will be conducted on the completion of the plant. This inspection will be conducted after the internal plastering has been completed and before the initial filling of plant. It will include checking of all dimensions of plant as specified.

Inspection at 4 stages should be carried out in 100% cases. All the verified points will be entered in a particular inspection form, signed by the inspector and the BCC's representative. One copy will be given to the BCC, one retained with the authority responsible for QC tasks.

Photos and videos at all stages are required to be taken as part of the record. In all cases soft copy of the photographs and videos are sufficient. Prints are not required.

- (a) Farm owner (or farm manager), BCC supervisor and quality inspector should be present in a photograph taken at each stage,
- (b) One photograph of the plant pit with animal shed in the back ground,
- (c) One photograph of the completed biogas plant,
- (d) One photograph of the electric generator connected to biogas,
- (e) One photograph of the milk chiller operating on the farm.

Level 3: Level 3 inspections will be carried out at 5-10% farms built by each BCC. This inspection will be carried out on the completed plants prior to initial filling and the finished dimensions shall be verified.

In general, at least five visits by the QC supervisor to the biodigester house/farm as shown in the flowchart given below is needed to ensure the complete compliance of the quality standards. However, visit-1 and visit-4 is proposed to be made by the technical persons from BCCs. It is mandatory to ensure that visit-2, visit-3 and visit-5 are made in all the biodigesters (100%) depending upon the progress of work in the field. Additional visits may be needed in case the BCCs request for such visits for specific purposes. The filed visits have to be planned in consultation with concerned BCCs. For each visits, a standard questionnaire has to be used to collect data and information from the field. Use of monitoring tools and equipment as given in Axnnex-3 need to be made as per the nature and purpose of visit while carrying out the monitoring/quality control activities.

The following diagram illustrates proposed timeline of such QC visits in general. As mentioned earlier, it is mandatory for the project authority to make at least three visits marked in bold letters.

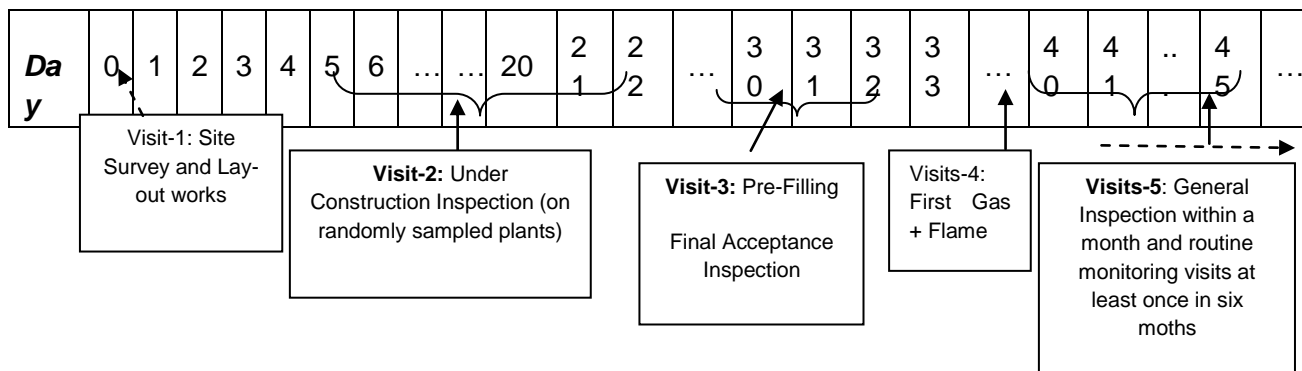

All the inspection findings are then entered into a Dbase; evaluated and monthly feedback provided to respective stakeholders. Company grading, incentives and penalty, need of training, revision of manuals etc. are done based upon database output.

Topic-2: Role of Biodigester Technicians

The technician's role is vital in the successful installation of biodigesters. The following are some of the major responsibilities of a technician:

Role-1: Promotion and Marketing

- Contact potential farmers who have enough dung to install biogas and motivate/encourage potential users to install biogas plants
- Provide necessary information on benefits of biogas plants to the (potential) users – **Never give false information!**
- Share success stories with potential farmers
- Distribute leaflets and other promotional materials to potential farmers

Role-2: Construct Quality Plant

- Help farmer in selecting proper size of biogas plant based upon the availability of feeding materials
- Ensure that the quality standards of construction materials and appliances are properly complied with the set standards
- Strictly follow design and drawing as provided to them during construction of biogas plants
- Comply with Construction Manual while installing the biogas plants
- Act upon the instructions and advices from supervisors and other project personnel
- Seek help from supervisors in case of any technical or other problems
- Take lead role of construction – ensure that the plant is not constructed by untrained person
- Show identity card when asked by supervisors



Role-3: Provide After-sale-services

- Provide O&M instruction to users and ensure that the users are provided with minimum requirement of knowledge and skill to operate various components of biogas plants
- Conduct routine visits of biogas households for problem solving and plant monitoring
- Act upon as early as possible the requests from users
- Carry out maintenance activities, if needed
- Ensure that instruction booklet (users' manual) and guarantee card are handed over to the users after the completion of construction

Role-4: General Support

- Support farmers to receive credit and subsidy from bank, if needed
- Support supervisors in organising community meeting, technical survey and other QC visits

Role-4: Reporting and Follow-up

- Ensure timely completion of the work without overloading the users
- Report progress and difficulties, if any, to supervisors regularly
- Receive comments and complains from the users and pass them to concerned authorities

The masons have to consider themselves as the users and carry out all the activities to satisfy the users. They have to remember that SATISFIED USERS will help in promoting their business.

If the concerned mason/plumber strictly follows the instruction as described in the construction manual, during the construction phase, the biodigester will function properly with anticipated efficiency and the owner will get the return of his/her investment. This will encourage his/her relatives and neighbours to install biodigesters. However, if the biodigester functions poorly, nobody will be motivated to install one. Poor quality plants will harm the reputation of biogas technology and will have a serious negative effect on promotion and extension. The masons therefore should be well aware that good quality plants will help to increase the rate of installation through the demonstration effect which will ultimately benefit himself, the farmer and the country as a whole.

Self-Assessment Questions for Participants

The participants of the training should assess themselves at the end of the training sessions designed for this module. The following probe-questions could be used as guidance for self-assessment process:

SN	Self-Assessment Questions
1	What are the steps for conducting 'lay out' of a fixed dome biodigester?
2	What are the critical aspects of excavating a pit to construct fixed dome biodigester?
3	What are different mortar/concrete ratios for constructing foundation, constructing masonry walls of digester, concreting gas holder, plastering of walls of digester and constructing inlet and outlet masonry wall?
4	What are different layers of treatment to make gas holder perfectly gas-tight?
5	What happens if the size of outlet is bigger or smaller than that given in the drawing?
6	What should be the size of slurry collection pits? Why are they constructed?
7	What happens if quality norms are not followed properly?
8	What should be the frequency of quality control visits to ensure compliance of quality standards?
9	What will you do with the data and information collected during the quality control visits?
10	Describe the roles and responsibilities of a mason?
11	What are the major roles and responsibilities of a technical supervisor?
12	What are some of the safety measures that need to be followed while constructing a biodigester?

Module-03: Install Pipeline and Electro- mechanical Components

Introduction

- a. **Title:** Install pipeline, appliances and electro-mechanical components of a fixed dome biodigester
- b. **Aim:** The overall objective of this module is to ensure that the participants are acquainted with the correct methods of installing pipes and biogas appliances and be familiar with different types of gas-filtration systems as well as machines (generators, pumps, induction motors etc.) to operate with biogas
- c. **Duration:** Total - 24 hours; Theory - 4; Practice - 20 hours
- d. **Competency Standards**

The following competency standards are covered under the framework of this module:

- i. Standard 6: Install pipeline, appliances and electro-mechanical components
- ii. Standard 8: Practice quality norms and ensure the compliance of quality standards while construction

e. Learning Outcomes

After completion of this module the participant will be able to:

1. Install pipeline
2. Install appliances/end use applications
3. Install gas filtration/purification system
4. Install pump and/or generator
5. Describe the importance of quality assurance while installing pipes and appliances
6. Practice quality norms during the installation of pipes and appliances
7. Describe the roles and responsibilities of a biogas technician
8. Practice occupational health and safety measures

f. Formative / sessional assessment at the end of the module

The following are the most appropriate assessment methods to gather evidence to evaluate the learning of participants for this particular module.

- direct observation, for example:
 - observation of the performance during on-the-job training
- structured activities, for example:
 - simulation exercises/role-plays for assessing understanding occupational health and safety during work
- questioning, for example:
 - interviews
 - self-assessment
 - verbal questioning
 - questionnaires
 - oral examinations
- portfolios, for example:
 - collections of work samples compiled by the candidate
 - historical evidence
 - information about life experience
- review of products, for example:

- products during on-the-job exercise
- work samples/products
- third party feedback, for example:
 - testimonials/reports from employers/supervisors
 - evidence of training
 - authenticated prior achievements
 - interview with employer, supervisor, peer

The following assessment instruments - the documented questions/assessment activities developed to support the selected assessment method/s used to collect the evidence of candidate competence could therefore be used:

- oral questions
- observation/demonstration checklists
- candidate self-assessment guides
- recognition portfolios
- workplace portfolios
- simulation activities
- definition of relevant workplace documents
- evidence/observation checklists
- checklists for the evaluation of work samples

The following table summarises learning units for this module and formative assessment guidelines:

LEARNING UNIT	FORMATIVE ASSESMENT	SCHEDULED DATES	
<ul style="list-style-type: none"> ● C6.1: Install pipeline ● C6.2: Install appliances ● C6.3: Install gas filtration/purification system ● C6.4: Install pump and/or generator ● C8.1: Describe the importance of quality assurance ● C8.2: Practice quality norms during construction ● C8.3: Describe the roles and responsibilities of a biogas technician ● C8.4: Practice occupational health and safety measures 	<ul style="list-style-type: none"> a. What are the critical areas that needs special attention while laying gas pipeline? b. How do you check leakage in pipeline? c. Name common types of biogas appliances? d. What are different types of filters commonly fitted for gas purification? e. Describe the modifications needed in conventional spark-ignition engine and compression-ignition engine to operate with biogas. f. What are the major quality norms that the technician has to consider while installing pipelines? 		

Outline of Learning Units for Module-3

Learning Units 1, 2, 3, 4, 5 and 6

Unit 1 - C6.1: Install pipeline

Unit 2 - C6.2: Install appliances

Unit 3 - C6.3: Install gas filtration/purification system

Unit 4 - C6.4: Install pump and/or generator

Unit 5 - C8.1: Describe the importance of quality assurance

Unit 6 - C8.2: Practice quality norms during construction

Topic-1: Installation of Pipeline and Electro Mechanical Components

1.1 Installation of Pipe, Fittings and Appliances

- To ensure required flow of biogas to the points of application, it is necessary to select the size of pipes keeping in view the length of pipeline and quantity of biogas needed for the peak hour. Bigger pipes are needed for longer distances and if more gas needs to be conveyed. For example, if the distance between the gas holder and generator is 30 meters and the rate of gas flow needed is 2.5 m³/hour, then pipe of ¾" diameter is needed. The following diagram shows the required pipe size for a given length and anticipated rate of biogas flow.

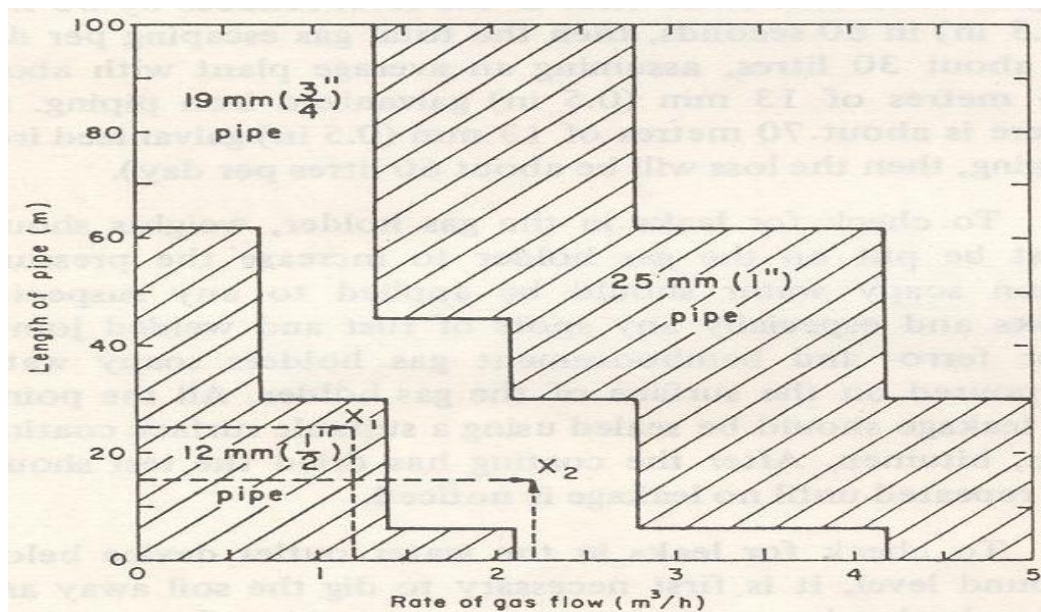

- Pipeline plays the important role of biogas transportation from the gas holder/ gas storage tank to the point of use. In the process of transportation the gas pressure drops due to resistance of the pipeline wall.
- The pressure drop due to the pipe resistance is proportional to the length of pipe.
- It is also inversely proportional to the diameter of the pipe.
- This drop should not exceed the allowable pressure drop.
- The gas pipe conveying the gas from the plant to users point is vulnerable for damages by people, domestic animals and rodents. Therefore, good quality pipe shall be used which must be, where possible, buried 30 cm below ground level.

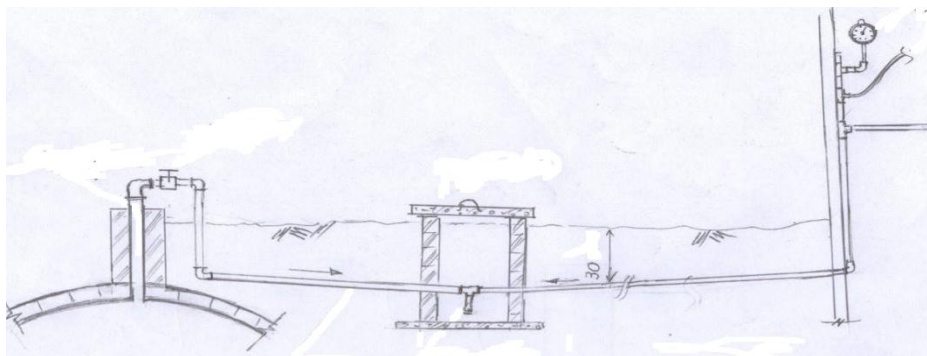

- The gas pressure at the point of use should not be less than the rated pressure of the appliance.
- Therefore in cases where long distances are unavoidable the pipe diameter should be increased to minimize the pressure drop in the line.
- As thump rule, the recommended diameters for different lengths of pipes are:
 - a. For distance of 1-25 meters 0.5 inch diameter
 - b. For distance of 25-150 meters 0.75 inch diameter
 - c. For distance of 150-400 meters 1 inch diameter



- A properly designed pipeline is one which does not cause a pressure drop of more than 2-3 cm of water column under any circumstances. 5 cm of water column corresponds to 0.075 psi.
- Fittings in the pipeline must be sealed with zinc putty and Teflon tape. Any other sealing agent, like grease, paint only, soap etc. must not be allowed.
- To reduce the risk of leakage, the use of fittings, especially unions, should be kept to a necessary minimum.
- To the extent possible, ball valves or cock valves suitable for gas installations should be used as shutoff and isolating elements. The most reliable valves are chrome-plated ball valves. Gate valves of the type normally used for water pipes are not suitable. Any water valves exceptionally used must first be checked for gas-tightness.
- A U-tube pressure gauge also known as manometer is quick and easy to make and can normally be expected to meet the requirements of a biogas plant. Take two glass tubes 1-1.5 meter in length with internal diameter of 1 cm. Fix them to a board or a wall inside a room and join the bottom ends with a rubber hose or plastic tube as shown. By the side of each tube,

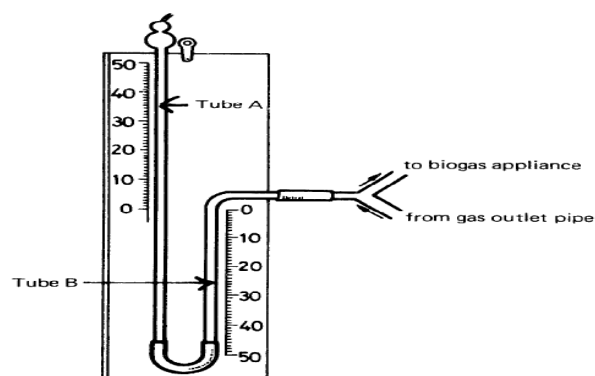

mark graduations in centimetre units. At the top of the tube AB, fix a round safety ball, or a bottle without a bottom. The capacity of bottle should be more than 200 millilitre. Fill with coloured water (to facilitate observations) up to the level of zero mark. Take Y tube and join to tube “A” and observe the change in water column in the U-tube, consisting of tube A, tube B and the rubber hose. From this we can tell the pressure inside the digester.

- The main gas valve has to be installed close to the biogas digester. Sealed T-joints should be connected before and after the main valve. With these T-joints it is possible to test the digester and the piping system separately for their gas-tightness. Ball valves as shutoff devices should be installed at all gas appliances. With shutoff valves, cleaning and maintenance work can be carried out without closing the main gas valve.
- No fittings should be installed between the main gas valve and dome gas pipe.
- For connecting burners with gas pipeline, use of transparent polyethylene hose pipe must be avoided. Only neoprene rubber hose of the best quality should be used. As soon as there is gas production, all joints and taps must be checked for leakage by applying a thick soap solution. If there is leakage the foam will either move or break.
- Install end-use applications such as generator, pumps as per the need of the users. It is important that the location of pump/generator should be safe – well ventilated and closed area. For increasing pressure a simple blower or compressor can be installed.



- The biogas coming from the digester is saturated with water vapour. This water vapour will condense at the walls of the pipeline. If this condensed water is not removed regularly, it will ultimately clog the pipeline. Hence, a water drain has to be placed in the pipeline.
- The position of the water drain should be inclined below the lowest point of the pipeline so that water will flow by gravity to the trap. Water can be removed by opening the drain. As this has to be done periodically the drain must be well accessible and protected in a well-maintained drain pit.
- The following steps should be followed to install water drain:
 - Identify a proper location for the water drain device.
 - Level the ground and complete the layout.
 - Take a cord of length 12 m and put an ink mark at 3 and 7 m.
 - First person will hold both the ends of the cord and the second person will hold the 3 m mark.
 - The second person will place the 3 m mark on a point on the ground and the third person while holding the 7 m mark will pull the string from the first person and place it on the ground in such a way that the sides of the triangle formed are 3, 4 and 5 m.
 - Mark the new location where the 7 m mark touches the ground.
 - Mark 60 cm on the 7 m length from the point 3 m.
 - Similar procedure is followed at the 3 sides of the pit.
 - It will then provide a square of 60 cm x 60 cm

- To check the square of the pit measure the 2 diagonals with a measuring tape.
- If the diagonals found are not equal repeat the lay out.
- This procedure will put the walls at 90 degrees.
- Mark the square with white powder.
- Excavate the pit such that the depth does not exceed 40 cm from the existing ground level.
- No soiling with any material is required.
- Brick work is then done.
- Once the brick wall reaches a desired height, lay the gas pipes opposite to each other with a slope of 1:100 from the 2 sides of the pit.
- Join the 2 ends of these pipes with a tee with one end facing towards the pit bottom.
- The tee should lie in the centre of the pit.
- Continue with the brick work until it is 10 cm above the existing ground level.
- Cement plaster work is started.
- Prepare a flat and clean surface for the casting of water drain pit covers.
- Spread a thin sheet of plastic over this surface.
- Make one piece for the cover slab.
- Plain Cement Concrete (PCC) is started.
- Pour the mix properly in the frames separately and pat the concrete surface gently so that the compaction avoids any formation of voids in the concrete.
- The thickness of the concrete slab will be 10 cm.
- Cover the frames with a plastic sheet for the night and avoid any damage by the rains.
- Sprinkle water on slab surfaces with water 4 to 5 times a day for at least 5 days for curing.
- Dislodge the frames from the casted slabs.
- Lift the cover slabs to remove the plastic sheets.
- Carry the slab and cover the pit.
- The main purpose of the water traps to trap condensed water and collect it in ensuring the regular flow of gas from the pipeline. Ideally, the piping system should be laid out in a way that allows a free flow of condensation water back into the digester. If depressions in the piping system cannot be avoided, one or several water traps have to be installed at the lowest point of the depressions. Inclination should not be less than 1%. Often, water traps cannot be avoided. One has to decide then, if an 'automatic' trap or a manually operated trap is more suitable. Automatic traps have the advantage that emptying - which is easily forgotten - is not necessary. But if they dry up or blow empty, they may cause heavy and extended gas losses. In addition, they are not easily understood. Manual traps are simple and easy to understand, but if they are not emptied regularly, the accumulated condensation water will eventually block the piping system. Both kinds of traps have to be installed in a solid chamber, covered by a lid to prevent an eventual filling up by soil.

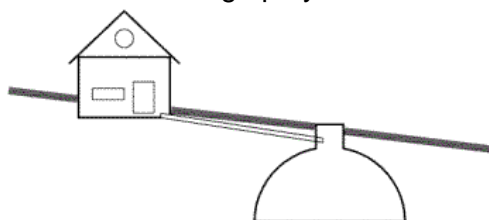

1: Piping system with straight slope from Point of use to digester. No water trap required as condensation water drains into the digester

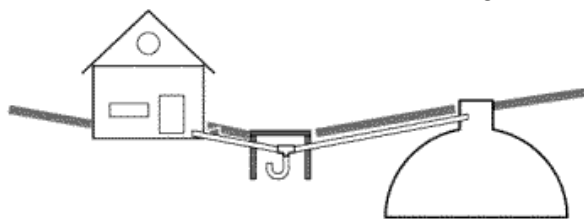

2: Wherever condensation water cannot drain back into the digester, a water trap becomes necessary

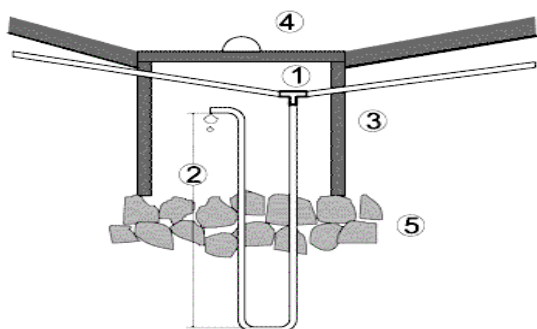

3: Automatic water trap: (1) T-joint in the piping system, (2) water column, equal to max. Gas pressure + 30% security, (3) solid brick or concrete casing, (4) concrete lid, (5) drainage

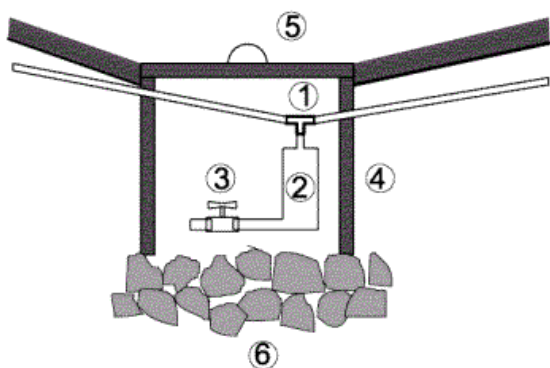

4: Manual water trap: (1) T-joint, (2) buffer storage for condensate water, (3) manual tap, (4) casing, (5) concrete lid, (6) drainage

POINTS TO CONSIDER

- It should be easy to replace the water drain device as a when required, therefore the size of the water drain pit should be suitable for a 30 cm (12") pipe wrench to work with.
- To avoid storm water from entering the pit and filling it with eroded soil the top edge of the water drain pit should approximately 5 to 8 cm above the ground.
- The thickness of the water drain pit should be made thin so that it could be lifted easily to operate the water drain.



- The bottom of the pit should not be plastered because the water released from the water drain device needs to be absorbed by the ground. But the sides of the drain pit can be plastered.
- Water drain pit can be either constructed near the house or at the centre of the pipeline. It should not be constructed near the turret.
- Depending on the terrain and distance, sometime more than one water drain devices needs to be installed in the pipeline.
- For installations where there is distribution of biogas to a number of users, the water trap is set at the lowest level of the common pipe (which should be the lowest level overall) so that only 1 no water trap needs to be done as routine operation rather than individually.

1.2. Installation of Gas Storage Tank

Given the larger size of biodigesters and the quantity of biogas produced, it is sometimes necessary to install a separate storage tank. Installation of storage tank will also help in providing biogas at required pressure to the point of application – the generators. Various safety mechanisms such as use of thicker gauge steel for manufacturing tank, installation of safety valves, flaring mechanisms etc. should be given due care while installing storage tank to avoid potential risks. The following diagram shows the storage mechanism.

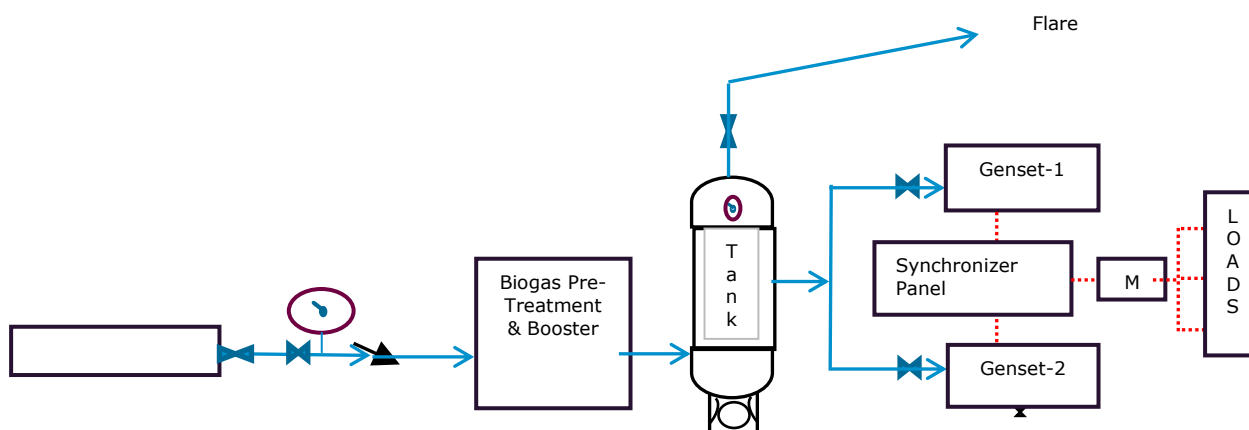

Fig: Gas Storage and Utilization System

The engineering specifications that had the most bearing on selecting a compressor include cost, safety, accessibility, lifespan, and efficiency. It was extremely important to balance lifespan and cost. An inexpensive compressor is desirable, but it also has to be reliable. Research indicated that a manually actuated, single-acting compressor, capable of reducing the volume by a factor of 3-4, would be an appropriate solution. The manufacturing of storage tank depends upon the reduction factor and required pressure needed to compress to meet the desired factor. The following table provides a thumb rule:

Table-3.1: Biogas Reduction Factor and Required Pressure

Reduction Factor	Required Pressure	
	Bar	Psi
2	2.5	35
3	4	55
4	6	84
5	8	112
6	10	140

For medium scale biodigester, the reduction factor of 2-3 could be followed. As the production and storage pressure of biodigester does not match the pressure requirements of the gas utilization equipment, compression can eliminate the mismatch and guarantee the efficient operation of the equipment.

1.3. Installation of Biogas Filter Unit

Among all impurities in the biogas, the CO₂, H₂S and moisture should be eliminated in order possible to be used as fuel of the engine. Biogas filtration system consists of mechanisms to remove CO₂, H₂S and moisture from the gas. Locally manufactured, simple mechanisms most widely used in different parts of the world should be designed and installed.



a. CO₂ Filtration:

For Carbon Dioxide filtration water scrubbing method is used. A steel cylinder with plain tap water inside it is placed. The biogas is bubbled in the water to reduce CO₂. The water can be replaced on weekly basis or bimonthly depending upon the change in colour of water, which can be seen in the transparent rubber pipe (column tube) attached on the side of steel case of the filter. The size of the cylinder could be 8 feet in height and 10 inch diameter (5.45 ft³) for 100 m³ plant and one third of the tank is filled with water. For 50 m³ plants, the capacity is 2.3 ft³.

b. H₂S Filtration:

The Iron Sponge process is used to remove H₂S. The unit consists of a gas tight cylindrical steel tank. The gas containing H₂S or the sour gas is passed through a bed of red oxide in the form of steel wool. The steel wool basically is the rusted iron chips found in the lathe workshop. The steel wool bed is placed at the bottom of the towers. The gas enters at the bottom of the tower, then passes through the bed and finally comes out on the top of the tower. The dimension of steel tank could be 8 feet in height and 10 inch diameter (5.45 ft³) for 100 m³ plant. The volume of tank for 50 m³ plant is 1.3 ft³. The amount of iron chips in in steel tank should be more than 3 kgs. Almost one fourth of the tank is filled with iron chips. The iron chips have a high affinity to react with H₂S. The chemical reaction of red oxide with H₂S is given in the following equation. $Fe_2O_3 + H_2S = Fe_2S_3 + 3H_2O$ (Manning and Thompson, 1991). After reaction with H₂S the iron chips becomes black iron sulphide. When the black corroded iron sulphide

reaches 75% height of the bed, it is time to change it and feed a fresh charge. The corroded steel wool can be reused after being oxidized to rust by exposure to air or heating it.

c. Moisture Filtration:

There are different materials used for moisture removal, such as alumina, silica gels, silica-alumina gels and molecular sieves. Silica gel is commonly used as an absorber. Silica gel is a hard, rugged material with good abrasion resistance characteristics. It is the product of chemical reaction between sulphuric acid and sodium silicate and consists almost solely of silicon dioxide (SiO_2). Gels can reduce the moisture content to 10 ppm and can be regenerated. They adsorb heavy hydrocarbons and release them easily during regeneration. A filter made of steel body casing is fabricated and filled with Silica Gel as moisture absorbents (desiccants) through which biogas is allowed to pass. The volume of steel tank is about 5.45 ft^3 for 100 m^3 plant and 1.3 ft^3 for 50 m^3 size containing 2 and 3 kg of silica gel respectively. The silica that is used for dehumidifier works well to eliminate the water content in the biogas. The solid silica can be crashed to become grain and regenerated after heating. After passing through these three filters, biogas is considered to be suitable for operating generator after carrying out minor adjustments in the carburettor or gas kit.

Topic-2: Electric Appliances

2.1. Modification of Diesel and Gasoline Engines

Biogas can be used in both CI (compression ignition) engines and SI (spark ignition) engines. The self-ignition temperature of biogas is high and hence it resists auto ignition, this is desirable feature in spark ignition engines, as it will reduce the chances of knock.



SI engine conversion to biogas fuelling involved engine modification as the following:

Mixing device: A gas mixing device (venturi) needs to be designed. It is usually a T-joint with a gas pipe that is protruding into the device. The gas pipe is cut in oblique shape, with its opening facing the engine inlet. The protruding section increases the active pressure drop for the gas to flow into the mixing device that joined the air filter and carburetion system together. A venturi needs to be introduced in to the system to enhance the mixing of air and fuel for improved combustion as shown below:



Spark gap setting: The use of spark gap between 0.017 and 0.030 inches for biogas is adequate with no noticeable difference in performance within this range. Thus, a spark plug of 0.55 mm (0.022 in) needs to be used which operated successfully with good performance.

Spark timing: Since biogas typically has a slower flame velocity relative to other gases fuels, spark timing must be retarded. The engine needs to be timed by gradually regulating the point in the cycle where the spark occurs at the spark plug until ensuring smooth combustion and maximum performance of the engine operation.

Compression ratio: Although optimum compression ratios for a biogas fuelled engine has been determined to be in the range of 11: 1 to 16: 1, a partial compensation can be achieved by raising the compression ratio to that range. Moreover, this will accomplish with increases in the mechanical and thermal load on the engine.

Modifications for diesel engine includes an addition of biogas carburettor for air-fuel mixing, replacing the fuel injection system with spark ignition system, reduction of compression ratio using a cylinder head spacer, and modification of the waste gate so the boost pressure can be adjusted. The engine needs to be tuned by changing air/fuel ratio, ignition timing, and boost pressure to obtain the optimum running condition.



Controlling the biogas pressure that feeds the combustion engine is critical, especially because the flow rate coming out of the fixed dome biodigester fluctuates. When the engine does not receive a constant pressure fuel supply its RPM begins to surge, which is not desirable in a generator application. A pressure regulator in the form of blower should be used to effectively regulate the biogas pressure at least at 4 psi. Trial and error method of adjusting fuel/air mixture and timing will be helpful to find the "sweet spot" for ignition.

The following picture shows the general arrangement for engine coupled with an induction motor.

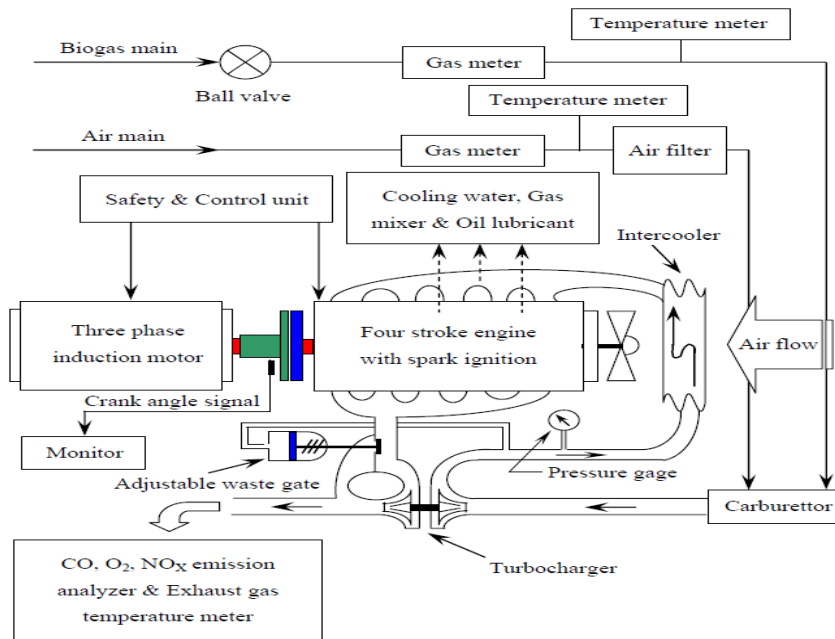

2.2. Electricity Generation from Biogas

- 1 cubic meter of biogas (1000 litre) contains 5000-6000 kcal of energy which produces a gross electricity of 6 kWh. The net generation of electricity depends upon the efficiency of engine which commonly varies in between 20 to 35%.
- With 30% efficiency of generator, it can generate about 1.8 kWh electrical energy from 1 cubic meter of biogas which is enough to operate a one horse power motor for 2.5 hours.
- Diesel engine is operated in dual fuel mode with diesel and biogas mixed usually at 20:80 ratio. The ratio can be as low as 50:50 depending upon availability of biogas.

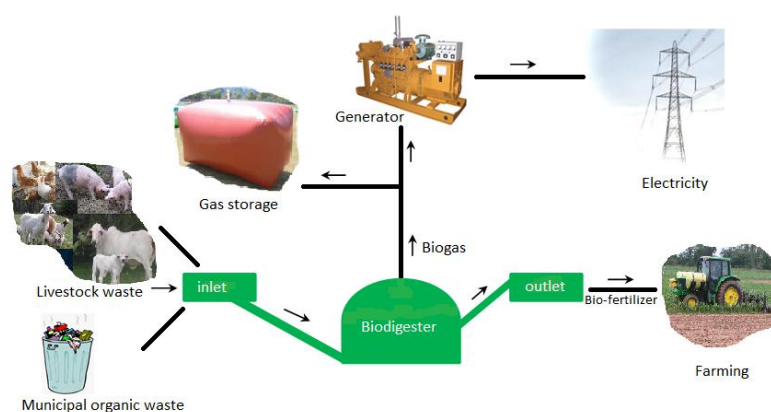

- Gasoline Engine can also be operated on biogas. The engine is started with petrol and then transferred to gas operation.
- Gas kit needs to be installed. Filtration of biogas to remove or at least minimize CO_2 , H_2S and moisture is necessary for smooth functioning of an engine.
- Robert Fick at Alliant energy reports that European generators obtain 0.15 kW of electrical power per cow on a continuous basis, while their American counterparts

manage 0.2 kW (or 4.8 kWh/day). The difference probably owes to differences in animal size and feed. These figures are for farm cows that are kept in cattle shed for 24 hours and condition of cattle shed is such that collection of at least 90% of the produced dung is possible.

- These figures correspond to generators using micro-turbines, with an assumed efficiency in electricity generation of 28%.

Learning Units 7 and 8

Unit 7 - C8.3: Describe the roles and responsibilities of a biogas technician

Unit 8 - C8.4: Practice occupational health and safety measures

Topic-1: Role and Responsibilities of Biogas Technician

The anticipated roles and responsibilities of technician has been described under Module-2. As the anticipated roles are similar for this module too, please refer the learning units in Module-2.

Topic-2: Occupational Health and Safety Measure

Measures corresponding to this learning unit have already been integrated in respective heading above.

Self-Assessment Questions for Participants

The participants of the training/course should assess themselves at the end of the training sessions/course designed for this module. The following probe-questions could be used as guidance for self-assessment process:

SN	Self-assessment Questions
1	How to decide/calculate the size of gas pipe? What happen if the size of pipe is smaller than needed?
2	What are some of the critical points to be remembered while laying/fixing biogas pipeline?
3	How do you make the pipeline gastight?
4	How do you check the gas tightness of the pipeline?
5	Why is water drain installed in pipeline? Where is the water drain fitted?
6	What are some of the biogas appliances commonly used in households/farms?
7	Why are filters needed? What happens if biogas is used to operate pumps/generators without filtering it?
8	What needs to be thoroughly considered to generate electricity from biogas?
9	Describe the changes needed on conventional diesel and petrol engines to operate it with biogas?
10	Why does the diesel engines need to be run on dual-fuel mode?
11	What will be requirement of biogas to run a 10 horse power engine for 10 hours in dual fuel mode of 20:80 ratio?

Module-4: Ensure effective operation and timely maintenance of biodigesters

Introduction

- a. **Title:** Ensure effective operation and timely maintenance of a fixed dome biodigester
- b. **Aim:** The overall objective of this module is to build capacity of trainees for effective operation and timely maintenance of biodigesters to ensure sustained benefits and optimal use of biodigester products – biogas and bioslurry to enhance benefits from biodigesters.
- c. **Duration:** Total – 32 hours; Theory – 16 hours; Practice – 16 hours
- d. **Competency Standards**

The following competency standard is covered under the framework of this module:

- i. Standard 7: Ensure effective operation and timely maintenance of Biodigesters

e. Learning Outcomes

After completion of this module the participant will be able to:

- | |
|---|
| <ol style="list-style-type: none">1. Describe routine operation activities for trouble-free functioning of biodigester2. Conduct minor repair and maintenance works3. Identify potential problems and likely solutions4. Explain methods for optimum utilization of biogas and bioslurry5. Instruct users for effective operation and maintenance of biodigester6. Ensure sustainable benefits from biodigester7. Describe the roles and responsibilities of a biogas technician for effective operation and maintenance8. Practice occupational health and safety measures during operation and maintenance |
|---|

f. Formative / sessional assessment at the end of the module

The following assessment methods should be used to gather evidence and a means of collecting evidence for this particular module.

- direct observation, for example:
 - operational activities, repair works
 - work activities in a simulated workplace environment for operation and maintenance
- structured activities, for example:
 - simulation exercises/role-plays for optimization of the use of biogas and bioslurry
- questioning, for example:
 - interviews
 - self-assessment
 - verbal questioning
 - questionnaires /oral examinations
- portfolios, for example:
 - collections of work samples compiled by the candidate
 - product with supporting documentation
 - information about life experience
- third party feedback, for example:
 - evidence of training
 - authenticated prior achievements
 - interview with employer, supervisor, peer

The following assessment instruments - the documented questions/assessment activities developed to support the selected assessment method/s used to collect the evidence of candidate competence could therefore be used:

- oral questions
- observation/demonstration checklists
- candidate self-assessment guides
- recognition portfolios
- workplace portfolios
- simulation activities
- definition of relevant workplace documents
- evidence/observation checklists
- checklists for the evaluation of work samples

The following table summarises learning units for this module and formative assessment guidelines:

LEARNING UNIT	FORMATIVE ASSESSMENT	SCHEDULED DATES	
C7.1: Describe routine operation activities for trouble-free functioning of biodigester C7.2: Conduct minor repair and maintenance works C7.3: Identify potential problems and likely solutions C7.4: Explain methods for optimum utilization of biogas and bioslurry C7.5: Instruct users for effective operation and maintenance of biodigester C7.6: Ensure sustainable benefits from biodigester C8.3: Describe the roles and responsibilities of a biogas technician C8.4: Practice occupational health and safety measures	a. What is the quantity of initial and daily feeding needed for a biodigester of 25 cum capacity? b. How do you conduct a gas-leakage test in the pipeline? c. How do you regenerate biogas filters? d. How do you solve the problem of slurry in the pipeline? e. What is the reason for turning the biogas stove flame from blue to yellow? f. What are comparative advantages of bioslurry? g. Describe what are general safety measures while using biogas for cooking?		

Learning Units 1, 2 and 3

Unit 1 - C7.1: Describe routine operation activities for trouble-free functioning of biodigester

Unit 2 - C7.2: Conduct minor repair and maintenance works

Unit 3 - C7.3: Identify potential problems and likely solutions

Topic-1: Operational and Maintenance of Biodigester

Proper operation and maintenance (O&M) of the different components of a biogas plant is very important for its efficient and long-term functioning. The users have a major responsibility of carrying out operational and minor maintenance activities as anticipated. It is therefore, necessary to orient and train users on these activities upon the completion of the construction works.

After the completion of the entire construction work, the site surrounding the biogas plant should be cleaned and cleared. The remains of construction materials have to be dumped properly in safe disposal areas. The top of the dome has to be filled with soil which acts as an insulation to protect the plant. The outside portion of outlet walls and base of the inlet should be filled with soil and compacted properly. Proper drainage system should be constructed to avoid rain water entering into the biodigester. Moreover, the mason has to provide proper orientation to the users on plant operation and minor maintenance. Importance of daily feeding of required quantity, operation of different appliances, major points to be remembered while operating the plants etc. should be explained to the users before leaving the construction site.

1.1 Checking of Gas and Water Tightness

After the completion of the construction of structural components and installation of pipes and appliances, and before feeding with mix of dung and water, biogas plants should be checked for water-tightness (the digester) as well as gas-tightness (the gas holder – dome and conveyance system – pipe and appliances). If the plant is not water tight, there will be the risk of leaking of nutrients from the slurry as well as alteration of water-dung ratio which affects the Hydraulic Retention Time adversely. A leaking biogas plant hence produces inferior quality bio-fertilizer. Likewise, if the gas holder, pipes and appliances are not air-tight, the produced gas will escape into the atmosphere resulting in less gas available for application (at the micro level) and detrimental consequences to environment (at the macro level). In other words, the efficiency and effectiveness of biogas plant highly depends on gas tightness of the gas-storage tank as well as pipes and appliances, and water tightness of the digester. Most of the biodigester units consist of a masonry/concrete dome, partly constructed in the soil, in which methane is produced.

There are different methodologies in practice to check the water and gas tightness of structures like biogas plants. However, the testing of biogas plants should be as simple as possible so that it can be performed at the local level with little time and efforts. The simplest techniques to perform these tests are described below:

a. Checking of Water Tightness

After the completion of the required finishing works inside the digester, it should be checked thoroughly for any minor visible cracks in the walls and floor. If cracks are seen these should be

repaired with chiseling and plastering. If there are no cracks, the following steps should be followed to check the water tightness:

- a. Fill the digester with water till the water level reaches at the slurry overflow level in the outlet tank. Leave it for 3-4 hours to allow the newly constructed walls to absorb water.
- b. Mark the level of water or slurry in the outlet wall once the water level becomes somewhat stable.
- c. Leave it for 24 hours and check the level of water again.
- d. Observe the change in water level after 24 hours. Measure the difference of water levels. If the drop is less than 3 cm in smaller plants (4 and 6 cum) and less than 4 cm in bigger plants (8 and 10 cum), the digester is water-tight. However, if the drop in water level is more than 4 cm in 24 hours the digester is not water tight.
- e. If water level drops down gradually, wait till the level become somewhat static. If the drop stops at certain height, it indicates that the leakage is occurring above that level. If the level continuously drops down to the floor level, the leakage should be either in the bottom of the wall or on the floor.
- f. A thin layer (5-7 mm) of plaster (1:3) with water-proofing compounds should be applied in the digester walls to avoid leakage.

b. Checking of Gas Tightness

i. Gas Holder

To check the gas tightness of the gas holder the following steps should be followed:

- a. Ensure that the digester and outlet tank are water tight.
- b. From already filled plant (for checking water tightness), take out some water so that, so that the water level in the outlet drops to 15 cm below the overflow level.
- c. Open the main gas valve placed in the top of dome.
- d. Pump air through the piping system (preferably by detaching the connection of stove and rubber hose pipe) with the help of small hand/foot pump similar to bicycle air pump till the level of water reaches to the overflow level in the outlet. Alternatively, the pressure could be noted in the pressure gauge fitted in the gas pipeline.
- e. Close main gas valve. Check any leakage in it and ensure that there is no leakage in it.
- f. Mark the level of water in the outlet tank. Also note the pressure reading in the pressure meter fixed in the gas pipeline.
- g. Wait for more than 4 hours.
- h. After 4 hours, check the water level in outlet as well as the pressure reading in the pressure gauge.
- i. If the drop of water level in the outlet tank is less than 2 cm, the gas holder is gas tight. Alternatively, if the pressure readings in 4 hours do not differ by more than 2 cm water column, the gas holder is air-tight. If the drop is more than 2 cm, the dome should once again be treated for gas tightness.

Note: *When testing gas tightness of rather large container like biogas plant, the measuring time should be as long as possible for better results (24 hours). It is necessary to let the gas pressure inside the plant become stabilized. Moreover, minor leaks cause only very small changes in the air pressure, and even sensitive measuring equipment does not react until a rather long time.*

Alternatively, the air tightness of the gas holder could be checked with smoke test. For this test, smoke producing substances such as sulphur, partially wet-sawdust or rice husk could be kept in a container that floats in the water inside the digester to produce smoke or smoke can be injected to the plant through gas pipeline. If there is any leakage in the gas holder, smoke will come out which will be easily visible.

ii. Conveyance System (Pipes and appliances)

To check any leakage from pipes and appliances the following steps should be followed:

- a. Ensure that there is no leakage from the main gas valve.
- b. Close the main gas valve; gas taps, water traps and any other valves in the pipeline.
- c. Pump air in the conveyance system through the rubber hose pipe that connects stove and gas pipelines till the pressure reading in the gas pressure gauge increases by 20 cm water column.
- d. Wait for 2 hours.
- e. After 2 hours, note the pressure reading in the pressure gauge.
- f. If the pressure reading decreases by more than 2 cm water column, then there is gas leakage in the conveyance system.
- g. To find out the exact point of leakage, apply soap water solution in the joints and appliances.
- h. The bubbles of soap water solution will either shake very fast or burst if there is leakage.
- i. Alternately, smoke could be injected in the pipeline to check any leakage through it.
- j. Repair the leakage once it is detected.

1.2 Operational and Maintenance Activities

The day-to-day operation of a biogas unit requires a high level of discipline and routine to maintain high gas production and to ensure a long life-span of the biogas unit. Many problems in the performance of biogas plants occur due to user mistakes or operational neglect. Often, these problems can be reduced,

- By less complicated designs that are adapted to the substrate, the climatic conditions and the technical competence of the user,
- By high-quality and user-friendly appliances,
- By design and lay-out of the biogas for convenient work routine,
- By proper training and easy access to advice on operation problems.

During design selection, planning, construction, handing over and follow-up, the biogas extension program should emphasize further on a reduction of the users' workload for operating the biogas unit and using the gas and the slurry. In particular during work peaks for farm work, it is important that the biogas unit relieves the user from work rather than adding to the workload. As a general rule, the farming family should have less work with a biogas unit than without it, while enjoying the additional benefits in terms of a clean fuel and high quality fertilizer.

The following are major operational and maintenance activities carried out in the biodigesters to make it function efficiently for a longer period.

- a. Feeding of biodigester (Initial and Daily Feeding)
- b. Use and maintenance of control valves and
- c. Checking of gas leakages and repair the leaking parts
- d. Use and maintenance of Water drain
- e. Cleaning of overflow opening in outlet

- f. Use and maintenance of gas stove, gas lamp and other end-use applications
- g. Use and maintenance of engines (gasoline generators or diesel (Petter) Engine coupled with an induction motor)
- h. Regeneration of filters
- i. Composting/maintaining compost pits
- j. Breaking of scum layer
- k. Reading of pressure gauge and adjusting of gas flow as per the reading
- l. Insulating the plant in cold areas

1.2.1 Feeding of Biodigester

Once the construction of biodigester is completed, it has to be filled with required quantity of feeding (cattle dung mixed with water) up to the zero level in the digester (level of bottom of outlet). As the quality of dung required for initial feeding of the digester is quite much (as shown in table below), the farmers should be informed in advance to collect and store cattle dung from the day they decide to install biodigester. As the preparatory works for construction and the actual construction will take some days, quite a lot quantity of dung will be stored in this period of time. The farmer may collect the dung from neighbouring households. The initial feeding material should contain slurry with high bacteria population; therefore, it is recommended that digested-slurry from existing biogas plants, if any, be added to the initial feeding as starter or seeding matter.



Before feeding/loading the digester, it need to be ensured that all the valves are open. Once the filling is done up to zero level, new slurry should not be added until the combustible gas is produced. Once gas production starts, the user has to feed the biodigester daily with the required quantity of feeding as prescribed. The quantity of dung to be fed is mainly determined by the size of the plant and the hydraulic retention time (HRT). HRT is the time needed for the full digestion of feeding materials inside the digester which mainly depends on:

- Type of feeding material (Carbon/nitrogen ratio)
- Total solid percentage in the feeding material
- Temperature in the digester
- pH Value of the feeding

The HRT for Pakistani context to digest cattle dung is taken as 40-50 days. The feeding material that enters into the digester from inlet should remain in the digester for 40-50 days to release most of the gas inherited by it. HRT is therefore the time needed by the slurry to traverse from one side of the digester to the opposite side assuming the flow is laminar.

Before feeding cattle dung to the plant, it needs to be properly mixed with equal amount of water in order to maintain required Total Solid (TS) of 6% - 10%. Human excreta can also be

fed by attaching toilet to the biodigester. However, precautions, such as controlling excessive water and avoiding the use of chemicals while cleaning toilet has to be taken to avoid the possible risk to the functioning of the plant. The following table shows the total quantity of feeding materials needed for initial and daily feeding of the digester.

Table-4.1: Feeding requirement and gas production

Bio-digester size (m ³)	Initial Feeding (cattle dung)	Daily dung feeding	Water to mix with dung (litre)	Use of Biogas Stove(hour)	*Use of Biogas Electricity
10	3,200	80-100	80-100	1x (10 Hrs.)	10 KVA 0.8 Hrs.
20	6,500	160-200	160-200	2x (10 Hrs.)	10 KVA 1.6 Hrs.
30	10,000	240-300	240-300	3X (10 Hrs.)	10 KVA 2.5 Hrs.
40	13,000	320-400	320-400	4x (10 Hrs.)	10 KVA 3.2 Hrs.
50	16,000	400-500	400-500	4 x (12.5 Hrs.)	10 KVA 4 Hrs.
75	24,000	600-750	600-750	4x (18 Hrs.)	10 KVA 6 Hrs.
100	32,000	800-1000	800-1000	5x (20 Hrs.)	10 KVA 8 Hrs.

**The time is for the whole day with 20:80 ratio of diesel mixed with biogas. The total time has to be divided in two portions. Half at one time and half after 12 hours.*

*** Part of biogas can be used for cooking purposes but in that case the capacity for electricity generation will proportionally reduce.*

Points to consider while feeding the plant

- Collect the dung that is fresh and do not contain straw or other materials
- In the case of pressure flushing of dung from the cattle shed, do not use much water; flush the manure with broom and water ensuring the ratio of manure and water not more than 1:2.
- Remove the unwanted materials such as remains of fodder, soil, stone etc. if any, from the dung/manure before mixing it with water. Put straw, remains of fodder and other organic matters in the compost pit – do not leave it near the inlet pit unattended.
- Do not wash the inlet tank with soap or detergent. Do not use much water to clean it.
- For feeding cattle dung, ensure that the ratio of dung and water by volume is 1:1.
- Do not use the dried or very old cattle dung to feed the plant.
- It is advisable to feed a new plant with the digested slurry (50-60 kg) from near-by biodigesters, if any.

Benefits of proper feeding

- It enables the plant to function correctly with optimum biogas production benefiting the users to the expected extent.
- It becomes easier to operate and maintain a plant as correct feeding minimises the risks of technical problems. It minimises the cost incurred in maintenance of biodigester components.
- As the plant is likely to be an example of success and benefit, it will have a good impact on the neighbours, which helps in promoting the technology and creating market for biogas.
- The installer will have satisfied users. They will have better reputation in the sector. It will help them to grow their business.
- The risks of formation of scum layer, dead volume in the base and entry of slurry in pipeline are reduced to a great extent.
- Plant functions trouble-free for longer period of time.

Liquid content in slurry can be tested using a rod. Dip the rod in the slurry in outlet tank. If solid contents of the slurry do not bond or



glue to the rod properly, it can be concluded that more water is used to feed the plant. If the solid contents stick in the rod and moves slowly by gravity, then the ration is correctly maintained. In contrary, if the solid content sticks heavily without any movement, feed contains less water than required.

Problems of under Feeding: If underfeeding continues for a long time, the gas production will decrease and the low gas pressure will not be sufficient to displace the slurry in the outlet tank. As a result, the slurry level in digester will rise. The simplest way to correct this situation is to stop gas use for some time so that the gas pressure inside the digester increases; the slurry level on the outlet tank increases. The manometer check will show increase in the gas pressure. The first corrective step would be to remove slurry from the outlet and allow the gas pressure inside the digester to increase until full pull pressure of about 1.427 psi. When the slurry level in the outlet is up to full height. Do not feed the digester during this period.

In larger biogas units; the dung, urine and other substrate usually enter the plant by pipes, channels, belts or pumps. The available substrate has to enter the digester as soon as it is available to avoid pre-digestion outside the digester. The functioning of the feeding mechanisms has to be checked daily. Separators for unsuitable material have to be checked and emptied. The amounts of substrate fed into the digester may be recorded to monitor the performance of the biogas plant.

Smaller plants in developing countries are fed by hand. The substrates often dung and urine, should be thoroughly mixed, plant residues should be chopped, if necessary. Obstructive materials like stones and sand should be removed from the mixing chamber. Simple tools like a rubber squeegee, a dipper, fork to fish out fibrous material, proper buckets and shovels greatly facilitate this work. Filling work is further made easier by smooth concrete stable-floors and a minimized distance between the stable and the plant.

1.2.2 Use of Main Gas Valve

The Main Gas Valves and other control valves are vital and important components of biodigester. The main valve fitted just near the turret between dome gas pipe and the gas-pipeline prevents the risk of loss of valuable gas due to leakage in pipeline and appliances. This valve eases the repair of pipeline. Since, leakage in the main gas valve will directly threaten the functioning of the plant, the users should realise the importance of this valve. The users should close the main gas valve when biogas is not in use. Failing to do so will lead to problems such as in-sufficient or no gas available for cooking and slurry in the pipe line.



Gas tap is fitted in pipeline to regulate the flow of gas to the stove as per need. This helps in optimisation of the use of the gas. Biogas conveyed to the point of application will have high pressure at the time when the level of slurry in outlet is up to the overflow level (gas is fully stored in the gas holder). The pressure gradually decreases with the use of gas. The rate of gas flow varies as per the pressure. Efficiency of the stove varies in different pressure and gas flow rate. To maintain the optimum efficiency of stove, pressure and gas flow rate needs to be adjusted to the required level. This function is done by gas tap.

There are high chances of leakage of gas through the gas tap when the washer gets wear and tear during the course of its use. Leakage may also be encountered if the washer is dry. The need to change or oil the washer should carefully be monitored.

Some form of carbon particles will be deposited in the smooth surface of the ball of main gas valve if the valve is half-opened. This will cause some wear and tear of the nylon washers which may increase the risk of leakage of gas in long run. Therefore, the main gas valve should fully be opened and closed during the time of operation.

If the main valve is difficult to operate due to stiffness, it indicates the need to lubricate and cleaning. Otherwise the chromium coated ball and rubber washer usually called 'O' ring will be worn-out leading to gas leakage. This problem should be fixed as soon as possible – delay may lead to changing of valve. Since, the valve is an expensive item; it is difficult to change frequently. Hence, prevention is always better than cure. The following steps have to be followed to repair and maintain the main valve:

- i. Disconnect the pipe line through the union.
- ii. Remove lock, washer and valve ball. Using lock pliers, (lubricate or replace if necessary)
- iii. Unscrew the knob screw by a screwdriver
- iv. Pull out the pin,
- v. Check the "O" ring of the pin, (lubricate or replace if necessary)
- vi. Check the surface of the valve ball for any carbon deposits or uneven surface, clean or lubricate if necessary.
- vii. Assemble in the sequence provided in the diagram below
- viii. Check the leakage after repair using shampoo/soap/detergent foam.

1.2.3 Checking of gas leakages

There is always risk of gas leakage through the joints in the pipeline and appliances. To avoid the excessive leakage, it is important to check the leakage routinely. The checking of gas leakage should be started from the dome gas pipe. The potential areas of leakages are joint between dome gas pipe and the nipple just before the main gas valve, joint between main gas valve and the pipeline, any joints in the pipeline, joints between gas taps and pipeline, joint between pipeline and gas lamp, and joints in filter systems. There may be leakages from the appliances too.



Soap and water solution should be used to check gas leakage. Soap or detergent mixed with water is vigorously shaken to make foam or bubbles. This foam is applied in the joints. If there is leakage, the bubbles in the foam will either break or move. Coloured smoke can also be passed to pipeline through rubber-hose pipe to check leakage. The escaping of coloured smoke from

the joints is easily visible if there is leakage. Moreover, the pipe near the joint turns to black if there is leakage. Burning of matches or fire in the joint is not the right way to check leakage.

All the pipe joints should be checked using shampoo foam thoroughly. At the time of inspecting leakage in the pipe line, main gas valve should be opened and the gas tap closed. If any leakage is detected, it should be repaired immediately.

Steps to repair leakages from pipe joint are as follows:

- i. Close the main gas valve.
- ii. Open the leaking joint using pipe wrench turning it in anti-clock wise direction,
- iii. Check the thread for possible damage - repair as necessary
- iv. Apply at least 10 layers of Teflon tape or zinc putty or sealing agent over the threads
- v. Re-fit the dismantled joint properly
- vi. Check for leakage using shampoo foam.

1.2.4 Use of Water drain

The biogas conveyed from the gas holder is saturated with water vapours. This water condenses when it comes in contact with the walls of the pipe. If this condensed water is not drained regularly, it will ultimately clog the pipeline and block the flow of gas. The flame starts burning yellow initially and in the long run if much water is accumulated the gas stove does not burn at all. Hence, a water outlet to drain the water is fitted in the pipeline. The main purpose of water drain is to trap the condensed water and collect in it ensuring the regular flow of gas from the pipeline. After some time this water drain is filled with water which needs to be released out periodically. The general procedure of operating water drain is:



- o Lift the cover-slab of the drain pit
- o Turn the water releasing nut anti-clockwise until water flows out.
- o Wait till the accumulated water flows out completely.
- o Close the nut once gas starts coming out instead of water.
- o Tighten the nut carefully.

As for other appliances, water drain pit should be inspected from time to time. Any foreign materials deposited in the drain pit should be removed. The surrounding of the pit should be cleaned to ensure that rain water does not enter into it.

The water drain should also be inspected to check for the functional status. The nylon washer and water release screw holes should be checked. The following steps should be followed:

- i. Close the main gas valve.
- ii. Unscrew the water releasing screw,
- iii. Check the hole in the water releasing screw: de-block the blockage, if necessary
- iv. Check the condition and thickness of the nylon washer- replace it, if necessary
- v. Assemble the parts correctly
- vi. Check for gas leakage using shampoo/soap/detergent foam.

1.2.5 Cleaning of Overflow Opening

Digested slurry flows out of the displacement chamber (outlet tank) through the overflow opening located at opposite side of the dome in the shorter wall of the outlet tank. This opening is prone to clogging due to accumulation of slurry. This accumulated dried slurry has to be removed from time to time to facilitate the continuous flow of slurry. If some portion of the opening is blocked with dried slurry, it will increase the volume of the outlet tank. Increase in volume of outlet will pose serious problem in the functioning of biogas digester as it will result in serious complications. One of these complications is the problem of slurry in the pipeline. Therefore, the users should maintain the overflow level clean from dried slurry at all time. Regular inspection of this opening is therefore necessary.



1.2.6 Use of Biogas Stove and Lamp

The gas produced in the biogas digester is used with the burning of the gas stove. Gas tap regulates the flow of biogas depending upon the pressure inside the biogas digester. In the gas stove, atmospheric pressure is regulated with the help of an adjusting ring installed at the burner pipe containing 2 holes of 8 mm diameter. The ring and the gas tap should be adjusted for high efficiency of stove. The ring should be adjusted in such a way that the flame is blue, divergent and it burns with clear hissing sound. If the flame is convergent and long, the efficiency of stove will be very low. Biogas stoves with single burner generally consumes about 350 to 400 litre of gas per hour.



The user(s) should follow the following steps for operating the stove efficiently:

- i. Ensure that the items to be cooked are ready near the stove.
- ii. Cover the holes in the burner pipe completely with regulating ring.
- iii. Burn the match or lighter before opening the gas valve and take it in one hand.
- iv. While with the other hand open the gas tap slowly and lit the stove.
- v. Place a cooking pot on the stove.
- vi. Adjust the regulating ring in the stove until the flame burns bluish, short and the sound is clearly audible.
- vii. Ensure that the flame burns concentrated in the bottom of the pot without escaping outside.
- viii. Lowered the flame as soon as the food is simmering.
- ix. Ensure that the stove is burned in closed room as burning in open will have considerable heat lost.
- x. Ensure that the burner holes are not closed and the burner cavity is not filled with liquids that escape while cooking.
- xi. Never close the primary air intake fearing gas leakage from it.

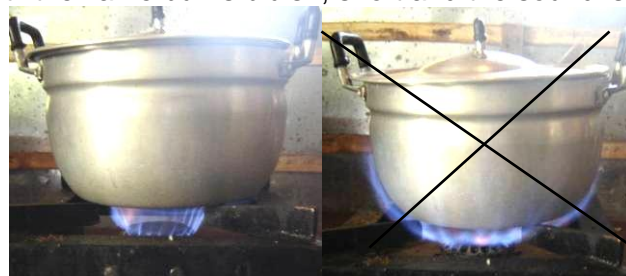

During cooking, foods and liquid spill out from the cooking pot and block the flame port and primary air holes. This leads to loss in efficiency of stove causing excessive gas use. This also creates problems such as insufficient gas for next food items. To avoid such problem, stove should be cleaned periodically.

The following are the steps to clean gas stove:

- i. Pull out rubber hose from the nozzle of the stove.
- ii. Pull out burner cap and clean all the flame ports,
- iii. Check the burner cup for deposit of dirt and clean it,
- iv. Check the nozzle for possible blockage and de-block it as necessary
- v. Check the primary air hole for possible blockage and de-block it as necessary
- vi. Check regulator ring for free movement.
- vii. Install the stove and check the performance.



Biogas produced in the household biodigester is used for lighting too. Different types of biogas lamps are available in the market. The Chinese model is widely used. Usually this model is supplied with a battery operated starter. The lamp is lit with switching of the starter. It is very easy to operate. Attention should be given to install this switch out of the reach of the children. The Chinese biogas lamps consume about 150 to 175 litres of gas per hour. Regular inspection is necessary to check the clogging of jet nozzle. Mantle should be changes when it gets punctured or broken. The following points have to be considered while operating a biogas lamp:



The glass-cover should be pre-treated with boiling in hot water before it is placed in position. The holes in clay-part (carborendum) should be checked any blockages regularly. While operating the lamp, one should ensure that the heat is reasonably far from any materials that catch fire easily.

Gas lamp needs routine repair and maintenance for faultless operation. Dismantling of a biogas lamp to clean its components, should be done carefully. The following steps are generally followed:

- i. Close the main gas valve.
- ii. Unscrew the reducer bush in the lamp
- iii. Unscrew the back nut and take off the reflector.
- iv. Unscrew the clay part (carborendum) by turning anti clockwise very carefully
- v. Inspect the nozzle, clean and be-block it if necessary
- vi. Assemble in the sequence
- vii. Check the performance.

1.2.7 Operation and Maintenance of Power Generator

Biogas can be used in both CI (compression ignition) engines and SI (spark ignition) engines. The self-ignition temperature of biogas is high and hence it resists auto ignition, this is desirable feature in spark ignition engines, as it will reduce the chances of knock. SI engine conversion to biogas fuelling involved some engine modifications. Locally available diesel engines are abundantly used in Pakistan to run with biogas. One horsepower power rating engine consumes

about 500 litres of biogas per hour. The following points need to be taken care while operating an engine with biogas:

For ignition, turn off the biogas valve and initiate the engine by using diesel as fuel. Once the engine starts and gets stable, **regulate the diesel throttle** to proper position (usually a little below the middle position). When the engine runs normally, turn on the biogas valve slowly. Regulated by the speed governor, the diesel feed reduces gradually. The rotating speed of the engine becomes steady. If biogas inflow is too much, diesel feed will be stopped intermittently and the engine will not be able to run smoothly. In this case, regulate the biogas valve to reduce the biogas inflow until the engine operation is smooth. In the process of operation, the method of regulating the rotation speed is the same as that of the pure diesel engine. When the rotating speed of the engine or the load changes, regulate the biogas valve to increase or decrease biogas inflow so as to ensure its normal operation and optimal consumption of diesel. To **stop** the engine, turn off the biogas valve first and then the throttle.

Points for Attention:

- Check biogas valve, pipes and joints regularly to inspect if there is any leakage.
- Ensure safety measures against a fire or explosion.
- Handle biogas valve smoothly, to avoid a sudden increased inflow of biogas into the engine, for it effects the normal operation of the engine.
- While the engine is running, try to keep the rotating speed steady, and avoid frequent change in operation of biogas valve.
- In case of shortage of biogas supply the engine needs to be fuelled wholly by diesel. In this situation, it is unnecessary to stop the engine. Just turn off biogas valve and continue operating the engine like a normal diesel engine.

Table-8 below summarizes common problems encountered with operating the generator with biogas and likely solutions.

Table-4.2: Problems with biogas engine, causes and likely solutions

SN	Problem	Potential Cause	Likely Solutions
1	After start, the engine speed does not reach normal The exhaust smoke is black or white, Sometimes engine stops	(a) Load is too much (b) Biogas is fed into engine too early (c) Engine is cold, especially in winters, (d) Engine is not lubricated well, (e) Quantity of air intake is less	(a) Start Engine and the loads are put on one by one, (b) Initiate Engine on diesel and then the let biogas in gradually, (c) Run engine without load and biogas for a while until it attains operating temperature, (d) Check oil level and charge, if required.
ii	Engine speed does not increase and the engine is unable to take up the load	Throttle handle is at minimum	Initiated engine with throttle in the middle position.
iii	On feeding the biogas,	Biogas is fed too	After initiation of engine on

	engine speed decreases, and even the engine stops	quickly resulting in too much gas and less air	diesel, turn on the gas valve slowly and gradually.
iv	Explosive sound is produced intermittently after initiation	Biogas inflow is too much	Regulate the gas valve to reduce biogas inflow
v	Explosive sound is produced intermittently during operation	The electrical load on the engine has reduced causing imperfect combination of biogas and diesel	Biogas valve should be regulated slowly and gradually to reduce biogas inflow

If the biogas supply is plentiful and load keeps steady, the biogas-diesel engine operated correctly may save diesel 75-90% of the diesel. To achieve good results of diesel saving, biogas supply should be plentiful and pressure of biogas coming into the engine should be above 0.07 Psi. More diesel fuel will be saved if the engine is operated for longer duration, load is kept steadier and the engine is stopped for lesser times. Diesel will also be saved by avoiding mistakes in the operation.

Controlling the biogas pressure that feeds the combustion engine is critical, especially because the flow rate coming out of the fixed dome biodigester fluctuates. When the engine does not receive a constant pressure fuel supply its RPM begins to surge, which is not desirable in a generator application. A pressure regulator in the form of blower should be used to effectively regulate the biogas pressure at least at 4 psi. Trial and error method of adjusting fuel/air mixture and timing will be helpful to find the "sweet spot" for ignition.

Maintenance routines recommended by the supplier/ manufacturer of the Power generator must be followed for daily/ weekly and other periodic inspections. The engine manufacturers recommend an accelerated oil change schedule for a diesel generator operating on biogas. This enables capture and removal of the H₂ S in the spent oil. The recommended oil change-frequency for engines operating on raw biogas is once every 300 operating hours. This has enabled Caterpillar 3306 engine at Langerwerf Dairy (California USA) for 45,000 hours between major overhaul.

The engine safety devices should be checked monthly for proper function. Other engine components require maintenance on monthly to yearly basis as recommended by the manufacturers. The maintenance schedule recommended by the engine/ generator manufacturers must be adhered to. As farms do most of their routine engine maintenance, their cost of routine maintenance is low.

1.2.8 Regeneration of Biogas Filters

Biogas is generated by the anaerobic digestion of organic solids that contain small amounts of H₂S. Although the total percentage of H₂S in biogas is relatively small, it is often sufficient enough to corrode metals and damage parts of equipment. This can create maintenance and operational problems especially in plants where the biogas is recovered to fuel engine-generators or boilers. In addition to corrosion problems, H₂S is a toxic air pollutant that can create a severe odour nuisance in minute concentrations. The treatment of biogas for removal of sulphur compounds has become increasingly important to restrict sulphur emissions. When biogas is burned or flared, the H₂S can generate sulphur dioxide (SO₂) emissions. Biogas contains H₂S in concentrations from 500 to 3000 ppm or more, depending on the composition of

feeding materials – cattle dung in this case. The odour of hydrogen sulphide becomes offensive at 3 to 5 ppm. An atmospheric concentration of 300 ppm can be lethal. Even small amounts of hydrogen sulphide can cause piping corrosion, gas engine pitting, and piston ring clogging. Many engine manufacturers require the H₂S content to be as low as 100 ppm.

Biogas from cattle dung may consist as high as of 40% CO₂ presence it. CO₂ has no heating value and its removal is required to increase the energy intensity of the gas per unit volume. Sometimes, CO₂ removal is also required because it forms a complex substance called CO₂.CO₂ which is quite corrosive in presence of water. For power generation, CO₂ presence in biogas reduces the air fuel ratio of the engine because to supply the same thermal input the system requires more biogas. Thus it reduces air flow into the engine under a constant volume. Limited air flow into the engine reduces the maximum output of the engine. However the overall efficiency of the engine does not change too much. Hence, for small scale power generation plant CO₂ removal is not mandatory.

Biogas filtration system consists of mechanisms to remove CO₂, H₂S and moisture from the gas. Locally manufactured, simple mechanisms most widely used in different parts of the world could be designed and installed under the framework of any biogas program in Pakistan.



a. CO₂ Filtration:

For Carbon Dioxide filtration water scrubbing method is used. A steel cylinder with plain tap water inside it has been placed. The biogas is bubbled in the water to reduce CO₂. The water can be replaced on weekly basis or bimonthly depending upon the change in colour of water, which can be seen in the transparent rubber pipe (column tube) attached on the side of steel case of the filter. The size of the cylinder is 8 feet in height and 10 inch diameter (5.45 ft³) for 100 m³ plant and one third of the tank is filled with water. For 50 m³ plants, the capacity is 2.3 ft³. The size of water scrubber has been found to be suitable.

b. H₂S Filtration:

The Iron Sponge process is used to remove H₂S. The unit consists of a gas tight cylindrical steel tank. The gas containing H₂S or the sour gas is passed through a bed of red oxide in the form of steel wool. The steel wool basically is the rusted iron chips found in the lathe workshop. The steel wool bed is placed at the bottom of the towers. The gas enters at the bottom of the tower, then passes through the bed and finally comes out on the top of the tower. The dimension of steel tank used is 8 feet in height and 10 inch diameter (5.45 ft³) for 100 m³ plant. The volume of tank for 50 m³ plant is 1.3 ft³. The amount of iron chips in in steel tank is reported to be about 3 kgs. Almost one fourth of the tank is filled with iron chips.

The iron chips have a high affinity to react with H₂S. After reaction with H₂S the iron chips becomes black iron sulphide. When the black corroded iron sulphide reaches 75% height of the

bed, it is time to change it and feed a fresh charge. The corroded steel wool can be reused after being oxidized to rust by exposure to air or heating it. The steel tanks are opaque and hence the change of colour of red oxide is not visible.

c. Moisture Filtration:

There are different materials used for moisture removal, such as alumina, silica gels, silica-alumina gels and molecular sieves. In these cases, silica gel is used as an absorber. Silica gel is a hard, rugged material with good abrasion resistance characteristics. It is the product of chemical reaction between sulphuric acid and sodium silicate and consists almost solely of silicon dioxide (SiO_2). Gels can reduce the moisture content to 10 ppm and can be regenerated. They adsorb heavy hydrocarbons and release them easily during regeneration. A filter made of steel body casing is fabricated and filled with Silica Gel as moisture absorbents (desiccants) through which biogas is allowed to pass. The volume of steel tank is about 5.45 ft^3 for 100 m^3 plant and 1.3 ft^3 for 50 m^3 size containing 2 and 3 kg of silica gel respectively. The silica that was used for dehumidifier in these cases was found working well to eliminate the water content in the biogas. The solid silica can be crashed to become grain and regenerated after heating.

For the regeneration of steel wool and silica gel, certain temperature needed. For steel wool the required temperature is 48.9°C and for silica gel it is 100°C . The exhaust gas of the engine at high temperature could be used through a heat exchanger to heat up steel wool and silica gel. A small compressor is used to supply fresh air into the biogas stream; this air passes through the heat exchange mechanism to carry the heat into the H_2S and moisture removal unit.

For continuous regeneration or revivification of steel wool or ferric oxide a small amount of air or oxygen is added to the inlet sour gas stream to oxidize the Fe_2S_3 back to Fe_2O_3 immediately after the H_2S is absorbed.

1.2.9 Composting of Slurry

If bio-slurry is composted the nutrient value will be added into it. Digested slurry is an excellent material for fastening the rate of composting of refuse, crop waste and garbage etc. It also provides moisture to the computable biomass. There are several ways of making compost. The widely used method is pit method and semi dried methods of slurry composting. The following steps have to be followed for pit composting of bio-slurry.

- First of all, prepare two compost pits, with volume equal to total plant volume, by the side of biogas plant at least 1 meter away from the plant
- Spread a thick layer of dry materials (15 – 20 cm), such as dry forest litter, waste grasses and straw, leftovers of animals feed and weeds collected from the fields, at the bottom of the pit which will absorb the moisture of the slurry and prevent from leaching of nutrients to the ground water system.
- Let the slurry flow on the dry materials so that the dry material is soaked with the moisture present in slurry.
- Cover the slurry with a thin layer of straw or any dry materials or stable waste. This is done to prevent slurry from drying. This preserves the plant nutrients.
- Next day, let the slurry flow in the pit. If possible spread the slurry equally over the dry materials in the pit and cover it with the same materials as used previously.
- Repeat this process every day till the pit is filled slightly 15 – 20 cm over the ground level and cover it with dry straw/ materials or a thin layer of soil and leave it for a month.

- Provide shade to the compost pit either by making bamboo structure and planting it with the creeping vegetables or by planting fruit trees like banana, fodder trees, green manuring plants or pulses like horse gram. It prevents the evaporation loss of nutrients from the compost pit.
- After a month, turn the compost and cover it with the same dry materials or a thin layer of soil.
- Turn the compost of the pit again after 15 days and cover it with the same materials as explained earlier. This process of turning will help the fast decomposition of composting materials. The compost thus prepared will be moist and pulverized.
- Start the filling of the second pit after the first pit is filled up. Follow the same procedure in filling the second pit.
- The decomposed slurry compost should be covered with dry materials or a thin layer of soil while the compost is in the pit or stored outside the pit.
- The compost should not be left exposed in the field for longer duration. It should be mixed with the soil as early as possible. This helps in avoiding the loss of nutrients because of excessive evaporation.

1.2.10 Breaking of Scum Layer

It is likely that a scum layer is formed in the digester because of the inert materials that float in the surface, like straw, hard or dried dung etc. This layer obstructs the flow of gas from digester to gas holder. The gas produced in the digester cannot penetrate this layer to reach the gas holder and thus, flows out of the manhole opening to the outlet. **If the feeding is done properly with qualitative feed, this problem never arises.** However, if scum layer is formed, this should be broken. This could be done by stirring the slurry inside the digester with the help of a rod or bamboo inserted through manhole.



Never enter into the plant to break scum. Entry into the digester should be avoided when there is slurry in the digester. For this the slurry should be removed for several days. Even after emptying the plant, allow 24 hours aeration as precautionary measure. Before entering, presence of harmful gases or sufficient oxygen should first be checked. Flames should be avoided near or within the digester. When one person enters the digester, another person should be constantly watching from outside to ensure the safety.

Scum formation can be minimized by agitation or stirring. Stirring is applicable only to the plants of batch feeding. In industrialized countries and for large plants in developing countries, engine driven stirring devices are the norm. Usually, but not always, they are operated automatically. The user, however, should check the operation of the stirring device daily.

Small and medium size biogas plants have manual stirring devices that have to be turned by hand as recommended. If there is no stirring device, poking with sticks through the inlet and outlet is recommended. The stick should be strong, long enough but not too heavy. It should

have a plate fixed at the end (small enough to fit in the inlet-/outlet pipes) to produce a movement of the slurry. Regular poking also ensures that the inlet/outlet pipes do not clog up. Experience shows that stirring and poking is hardly ever done as frequently as it should be. Farmers should be encouraged to run a trial on gas production with and without stirring. The higher gas production will convince the user more than any advice. As 'prevention is always better than cure' special care has to be provide to avoid cum formation. Correct feeding practices will reduce the chance of scum formation.

1.2.11 Use of Pressure Gauge

Pressure gauge is fitted in the gas-pipeline near the point of application of biogas to monitor the pressure of gas that flows to the appliances. When the needle of the pressure gauge indicates higher pressure, then the gas tap should be adjusted to allow less gas to flow to the stove or lamp and vice versa. Importantly, when the indicator shows full pressure, gas has to be used otherwise there is chance of gas leakage to atmosphere, which should not happen from the environmental point of view. Likewise, when the gas pressure is very low, one has to stop using the gas to avoid slurry in the pipeline. If the pressure is less than 15 cm water column, it is not preferable to use gas anymore.

A manometer is a tool used to measure the gas pressure. It is simple in construction and easy to use. (See figure below). For 10 cm difference in the water level on either side there is a corresponding change in pressure of a 1/100 of an atmosphere. Standard atmospheric pressure is 14.5 psi, therefore 10cm difference correspond to 0.145 psi difference of pressure on the two sides.

Example: If the level in the tube "A" drops by 20 cm and the water level in tube "B" rises by 20 cm, then the pressure difference is 40 cm – this will be called an internal pit pressure of 40 cm. It corresponds to the pit pressure of $(40/10) \times (0.145)$ psi; (which is 0.580 psi).

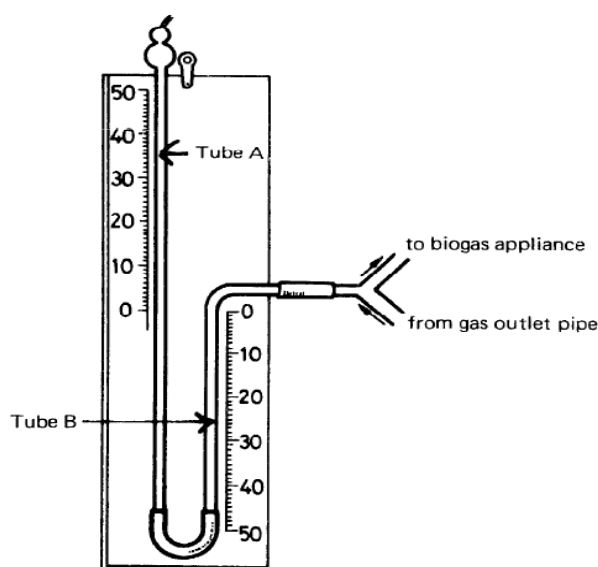

Note: The glass tube may be replaced with a tube made from any hard, transparent material with low thermal expansion coefficient.

This manometer could be replaced with a pressure indicator available in the market and suitably installed in the gas pipeline, Use manometer or the pressure meter to check gas pressure before using gas. Pressure should be at 10-80 cm. **When the compressor is operated on the**

gas outlet; it should not be allowed to extract gas below the 1 PSI gas pressure in digester.

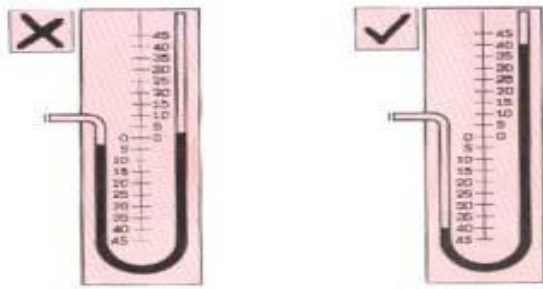

1.2.12 Insulating the plant in Cold Areas

The rate of fermentation is much faster at high temperature. Most rural household biogas plants (digesters) in developing countries operate at ambient temperatures, thus digester slurry temperature is susceptible to seasonal variation but is more dependent on the ground temperature than the atmospheric temperature. As a result, gas output in winter falls by up to 50 %. Below a slurry temperature of 10°C all the reactions cease to take place but revive gradually with the rise in temperature. To ensure workable temperature inside the digester in cold season, the following tips could be practiced:

- Plants should be constructed in a sunny place and any object blocking the sun should be removed.
- Carry out heap composting on top of the dome by mixing slurry and other organic dry materials such as straw, leaves and agricultural waste. Thickness of such composting should be of 2 to 4 feet and if the composting is covered with mud plaster the heat produced during composting will be preserved to maintain optimum temperature for biogas production in colder seasons/regions.
- Even if composting is not done, one should cover the dome portion of the biogas plant to maintain the temperature in the cold season and/or colder regions of the country. Should always maintain 40 cm top filling on dome.
- Mix dung and water in the morning and let it heat till afternoon before feeding the plant, this too will help to maintain the temperature in colder seasons/regions.

Radical drop in digester temperature, higher difference in minimum and maximum temperature affects gas production negatively and causes problems to the plant functioning.

To maintain constant temperature during day and night and provide enough counterweight against the gas pressure inside the biodigester, the top of dome has to be filled with at least 30 cm of earth layer. Since, the top of the dome is exactly at the ground level, it has to be covered with compacted earth from all sides. The filling is prone to erosion due to rain; hence it should be maintained properly. Necessary measures to protect erosion should also be taken.



1.2.13 Changing of rubber hose pipes/connecting pipes

Rubber hose pipe used (i) to connect main gas pipeline and end use devices, and (ii) in filter systems, may develop cracks due to heat and wear & tear due to longer use. The ends of rubber hose pipe where stove/generator nozzle and gas tap/valve is fitted expands in diameter causing leakage. Therefore, it should be checked for cracks and leakage of gas from the area where it is fitted. If there are cracks rubber hose needs to be replaced and the expanded ends should be cut off.



Steps to inspect rubber hose pipe:

- i. Pull out the rubber hose from the nozzles,
- ii. Bend or twist the rubber hose at several places and observe for cracks
- iii. If cracks are observed change the rubber hose
- iv. Check the ends of rubber hose if the ends are enlarged, cut off the portion that is expanded.

Topic-2: Common O & M Problems, Causes and Potential Solutions

It has been experienced that the biogas recovery projects have failed in past because of one or more reasons listed below:

- Operators did not have the skills or the time required to keep a marginal system operating.
- Selected digester systems were not compatible with the manure handling methods.
- Some designer/builders sold “cookie cutter” designs to farms. For example, of the 30 plug flow digesters built, 19 were built by one designer and 90 percent failed.
- The designer/builders installed the wrong type of equipment, such as incorrectly sized engine-generators, gas transmission equipment, and electrical relays.
- The systems became too expensive to maintain and repair because of poor system design.
- Farmers did not receive adequate training and technical support for their systems.
- There were no financial returns of the system or returns diminished over time.
- Farms went out of business due to non-digester factors.

When users report problems with biodigester or if biodigester stops functioning, the following are the steps to be taken to identify the potential problem:

Table-4.3: Checking of Biodigesters

When Biodigester Does not work, check the following information (twice)	
•	Feeding
–	Quantity
–	Mixing ratio and mixing quality
–	Source (contamination, old / dry)
–	Quality of water
–	Inoculation required?
•	Outlet
–	Discharge?
–	Foam
–	Odour, colour
–	pH
–	Slurry level – fluctuations
•	Pressure
–	Dome leakage
–	Pipe leakage

The following table summarises common problems, potential causes and likely solutions.

Table-4.4: Common Problems, causes and potential solutions

Problem	Cause	Potential Solution
Biogas is not produced even after 10-15 days	No bacterial activity inside the digester	<ul style="list-style-type: none"> ○ Ensure that the first feeding is done with fresh cattle dung. ○ Mix bio-slurry from existing plant as seeding agent. Wait for a month and see if gas production starts. If not, then empty the digester, and refill plant with fresh cattle dung.
	Leakages in dome (gas storage), or in pipes and appliances	<ul style="list-style-type: none"> ○ Check the main gas valve if it has leakage. ○ Close the main gas valve and see if the slurry level rises in outlet tank or not. If the level rises, then there is leakage from either pipeline or appliances. Check for leakage and correct it. ○ If the slurry level does not rise even after closing of main valve, there may be leakage in dome. ○ Wait for a month and see if gas production starts. If not, then empty the digester, check leakages from dome and refill plant with fresh cattle dung.
Stove does not burn even after gas production	More CO ₂ in gas	Escape some gas daily for about a week. When CO ₂ finishes, stove will burn.
	Defective fitting of pipe and appliances	Check if the pipe and appliances are fitted properly. Ensure that the main valve is open, gas tap is open and air intake in stove works properly
Enough gas in plant but stove and lamp do not burn	More CO ₂ during initial digestion	Escape some gas daily for about a week. When CO ₂ finishes, stove will burn.
	Clogging of gas pipe, gas tap or gas jet due to dirt	Be-block the pipeline. Clean/un-clog the tap and jet
	Clogging of pipeline due to water or slurry from digester	Drain water through outlet Check the size of outlet tank and if it bigger than recommended, lower the height of overflow opening
Less gas production than anticipated	Improper feeding (less or more quantity, irregular, more water, low temp. in	Correct the feeding practice and do as recommended; Do not use more water to clean inlet tank; Do not use much

	digester)	water in toilet; Mix dung and water properly
	Leakage of gas from gas holder and conveyance system	Check if there is leaked from main valve, pipeline and appliances with the use of soap water solution. If no leakage found then, check if gas is leaked from dome. Close the main gas valve; do not use gas for one or two days. Check the slurry level in outlet. If it is gradually decreasing, there must be leakage from dome. Empty the plant and apply treatment measures.
	Formation of scum layer in top or accumulation of sludge in bottom	Do not use other materials than the recommended for feeding; Stir slurry in digester with pole or rod to break the scum. Correct the water dung ratio.
	Use of chemicals in cleaning toilet	Avoid using chemicals in toilet; Use brush and water only to clean; Empty the plant if chemical is used, and fill with fresh dung; Do not use dung from cattle which is given strong antibiotics. Do not use soap/detergent to clean inlet.
The flame is not strong and blue, it is pale and yellow	Clogging of gas tap and burner holes with dirt or accumulation of cooked items	Clean the gas tap, oil it. Clean the burner holes with needle boil it in water. Clean the secondary air mixing chamber.
	Water or little slurry is accumulated in pipeline	Use water outlet to drain water. Clean the slurry.
	No or very little gas in plant	Close the main gas valve and allow time for gas production
	Primary air intake is blocked or not operated properly	Use primary air intake properly. If the hole is blocked, de-block it.
The stove burns with long and weak flame	Improper mixing of primary air	Adjust the primary air intake until the flame becomes strong
	Clogging of some of the holes in the burner cap	Clean the burner cap and de-block the holes with needle.
The flame 'lifts off' or flame is too big	Excessive flow of gas, high gas pressure	Reduce the gas flow. Reduce air supply.
The flame extinguishes or flame is too small	Less flow of gas, not enough pressure	Increase the gas flow. Check for blockages. Wait for some time till enough gas is produced.
Often slurry inters into the pipeline	Not enough feeding	Feed as per recommendation
	Not enough time left for accumulation of gas	Ensure that plant get free time to accumulate gas. Stop continuous use of

		gas for longer duration.
	Mixing of chemicals in slurry in digester	Avoid chemicals to clean toilet or inlet tank. Do not mix other materials such as urea while feeding plants Separate the dung of animal who is given hard medicine and do not use it Avoid cleaning of inlet with soap/detergent
	Gas is leaked from gas holder or main gas pipe or main gas valve	Use the main gas valve regularly. Check the leakage and stop it. If problem still persists, call the technicians
	The outlet is oversized or the pressure height is more than recommended	Lower the height of outlet, with repositioning overflow outlet at lower level
	Suction due to vacuum in pipeline	Close the gas taps first before closing the main gas valve.
Slurry does not flow out of overflow opening	Lesser and irregular feeding	Feed the plant as recommended
	Cracks in digester wall and/or outlet wall	Check the cracks in digester and outlet walls; if found repair it.
	Blocking of overflow opening	Check the overflow opening regularly and clean it as needed
The digested slurry coming out of outlet has strong foul smell	The digestion process is not as anticipated may be because of: <ul style="list-style-type: none"> ○ Short-circuiting of feeding in the digester ○ More quantity of water added ○ There is no bacteria in digester 	<ul style="list-style-type: none"> ○ Ensure that the inlet pipe discharges just opposite to outlet opening. ○ Ensure water dung ratio 1:1 while mixing dung to feed into the digester ○ Stop any adverse activities that kill bacteria such as use of chemical to clean latrines attached to biogas plant.
More time needed to cook food	Efficiency of flame is not as anticipated due to heat lost or defective stove	<ul style="list-style-type: none"> ○ Ensure that the primary air intake is adjusted properly to produce strong blue flame that concentrates in the bottom of cooking pot. ○ Ensure that the stove is properly maintained and used. ○ Ensure that the area of cooking is not windy and open. Locate stove in closed space to avoid heat lost.
Water in the manometer fluctuates up and down	Water in the pipeline	<ul style="list-style-type: none"> ○ Drain water from water trap. Ensure that all the water in the pipeline is drained away.

The engine does not run properly with biogas	As described in Table-4.2	○ As described in Table-4.2
--	---------------------------	-----------------------------

Learning Units 4, 5 and 6

Unit 4 - C7.4: Explain methods for optimum utilization of biogas and bioslurry

Unit 5 – C7.5: Instruct users for effective operation and maintenance of biodigester

Unit 6 – C7.6: Ensure sustainable benefits from biodigester

Topic-1: Optimum Utilisation of Biogas and Bioslurry

1.1. Use of Biogas

The energy content of biogas is most commonly transformed into heat energy for cooking, lighting and running simple dual-fuel engines. However, use of biogas for combustion engines and for absorption fridges are less suitable for domestic biogas as they require large quantities of gas and/or purified gas at a constant pressure. Also, it is also not feasible to compress biogas into a liquid form and store/transport it in gas cylinders. However, Biogas can be used like any other combustible gas, e.g. LPG. Each gas has its own properties which must be observed for efficient combustion. The main influencing factors are: gas/air mixing rate; flame speed; ignition temperature; and gas pressure, respectively volume of gas flow per time.

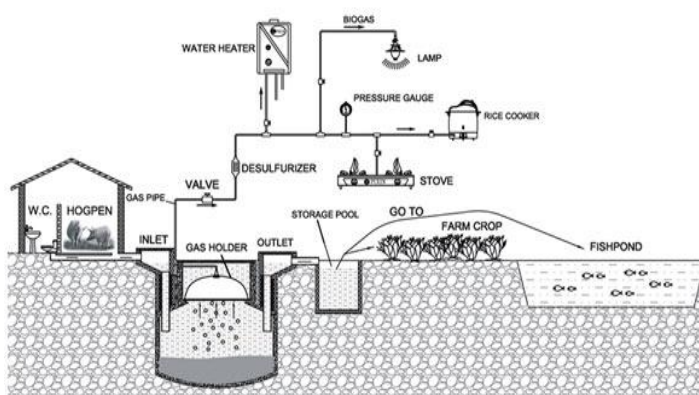

One ordinary biogas stove with a single burner, commonly used for domestic purpose, consumes 350 to 400 litres of gas per hour. In other words, 10 kg of cattle dung will be enough to produce enough gas to burn a stove for one hour. A biogas lamp consumes slightly less than half the quantity needed for a single-burner stove (150 to 175 litres of gas per hour). Operating an engine is not preferable with household biodigesters because of the fluctuations in gas pressure and the presence of other gases than methane that will harm parts of the engine.

Compared to LPG, biogas has a lower calorific value and needs less air per cubic metre for combustion. This means, with the same amount of air more gas is required. Therefore, gas jets are larger in diameter when using biogas. About 7 litre of air are required for total combustion of 1 litre of biogas, while for butane it is 31 litres and for propane 24 litres. The flame speed of biogas is relatively low, lower than that of LPG. Therefore, the flow speed must be less to avoid lifting the flame off the burner. The flow speed is defined by the total volume of gas (biogas + air) and the size of the opening the gas is passing through. The critical ignition temperature of biogas is higher than that of diesel. Therefore, when biogas is used in engines, ignition spark plugs are required or partly diesel must be added to the gas (dual fuel) to ignite the fuel and run the engine. Because of its low flame speed, slow turning diesel engines (below 2000 RPM) suit biogas better than fast turning diesel engines (above 5000RPM).

The efficiency of using biogas is 55% in stoves, 24% in engines but only 3% in lamps. A biogas lamp is only half that efficient than a kerosene lamp. The most efficient way of using biogas is in a heat-power combination where 88% efficiency can be reached. But this is only valid for larger installations and under the condition that the exhaust heat is used profitably. The use of biogas in stoves is best way of exploiting the energy needed by farm households.



1.2. Use of Bio-slurry

Biogas slurry is one of the two end products of the anaerobic digestion in the biogas plants. The mixture of animal/human waste and water put into the biogas plant undergoes a process of anaerobic digestion or fermentation in a bio-digester. During digestion, about 25 – 30% of the total dry matter of animal/human waste will be converted into a combustible gas and the residue of 70 – 75% of the total solids content of the fresh dung comes out as sludge which is known as biogas slurry or bioslurry.

Biogas slurry consists of 93% water and 7% dry matter of which 4.5% is organic and 2.5% inorganic matter. The percentage of NPK (Nitrogen, Phosphorus and Potassium) content of the slurry on wet basis is 0.25, 0.13 and 0.12 while on dry basis it is 3.6, 1.8 and 3.6 respectively. In addition to the major plant nutrients, it also provides micro-nutrients such as zinc, iron, manganese and copper that are also essential for plants, but required in trace amounts.

Biogas slurry can be used for a variety of purposes, the main one being organic fertiliser in farms, especially in vegetable and fruit gardens. The following are some of the applications:

- Organic fertiliser in farms
- Organic fertiliser for mushroom culture
- Seed treatment
- As supplement feed for some animals and fish
- Organic fertiliser to grow algae to increase fish production

As organic fertiliser, it can be used wet or dry. The slurry can be used directly by mixing it with irrigation water. Wet application is rather cumbersome; therefore farmers prefer to use dry slurry in their farms. For the dry use, composting of the slurry is highly recommended.

The following table shows the N, P, K values in different types of organic fertiliser (BSP-2006):

Table-4.5: N, P, K values in different types of organic fertiliser

Nutrient	Fresh Bioslurry (toilet not attached)	Fresh Bioslurry (toilet attached)	Composted Bioslurry	Manure from Toilet	Farm-yard-manure	Cattle urine
Nitrogen %	1.89	2.12	1.7	1.4	1.42	25
Phosphorus %	1.84	1.87	1.04	1.0	1.02	3.3
Potassium %	1.85	1.82	0.56	1.5	1.71	1.87

It can be seen from the above table that bio-slurry has better nutrient values in comparison to other organic fertilisers. The effect of compost on crop production depends upon the type and condition of the soil, the quality of the seeds, the climate and other factors. However, application of compost will bring the following changes to the soil:

- Improvement of the physical soil structure.
- Increased soil fertility.
- Increased water-holding capacity of the soil.
- Enhanced activity of the micro-organisms in the soil.

Various research studies done in Nepal have indicated that the use of bio-slurry helps in increasing the yields of agricultural productions to a considerable extent. Compared to farm yard manure, application of digested slurry increased the yields of rice, wheat and maize by 6.5 %, 8.9 % and 15.2 % respectively. Effluent compost, if stored and applied properly, improves soil fertility and increases cereal crop production with 10-30 % compared to farm yard manure (FYM). Several researches have shown that the application of liquid effluent on paddy, wheat and maize increases the yield by 10, 33 and 37% respectively. Compost application versus non application has given a yield increase of 80% in cauliflower, 67% increase in wheat and 21% in tomato. The most responsive crops to effluent compost are vegetables like root crops (carrots and radish), potatoes, fruit trees and rice.



a. **Application of Slurry in Semi-liquid Form**

The most economical way to apply slurry is by means of gravity, either by a network of small slurry furrows or by mixing slurry in the irrigation system. Both options require a gradient of at least 1% (for irrigation water) and 2% (for slurry distribution), sloping from the biogas plant's overflow point to the fields.

Making best and least labour-intensive use of the slurry is an important planning parameter. Especially where gravity distribution is feasible, the positioning of the biogas plant and the expansion chamber and the level of the expansion chamber overflow are of high importance. In rather flat areas, it should be considered to raise both the stable and the biogas-plant in order to allow a slurry distribution by gravity.



The digested slurry can directly be applied in the field using a bucket or a wheel barrow. An alternative to this is to discharge the slurry into an irrigation canal. However, these methods of direct application have some limitations. Firstly, not all farmers have irrigation facility throughout the year. Secondly, in the cascade system of irrigation in which water is supplied from one field to another, slurry is not uniformly distributed in the fields. The digested slurry is in a liquid form, it is difficult to transport it to farms located far from the biogas plants. The sludge and slurry could be applied to the crop or to the soil both as basal and top dressings. Whenever it is sprayed or applied to standing crop, it should be diluted with water at least at the ratio of 1:1. If it is not diluted, the high concentration of available ammonia and the soluble phosphorus contained in the slurry will produce toxic effect on plant growth “burning the leaves”.



b. Application of Slurry in Dried Form

The high water content of the slurry causes difficulties in transporting it to the farms. Even if it is applied wet in the field, tilling is difficult. Due to such difficulties, the farmers usually dry the slurry before transporting it into the fields. When fresh slurry is dried, the available nitrogen, particularly ammonium, is lost by volatilization. Therefore, the time factor has to be considered while applying the slurry and in this regard, immediate use can be a way of optimizing the results.



c. Utilization of Slurry for Compost Making

The above mentioned difficulties can be overcome by composting the slurry. If the slurry is composted by mixing it with various dry organic materials such as dry leaves, straw, etc., the following advantages can be realised:

- The dry waste materials around the farm and homestead can be utilized.
- One part of the slurry will be sufficient to compost about four parts of the plant materials.
- Increased amount of compost will be available in farm.
- Water contained in the slurry will be absorbed by dry materials. Thus, the manure will be moist and pulverized. The pulverized manure can be easily



transported to the fields.

Furthermore, the complete digestion of cattle dung in a biogas plant destroys weed seeds and organisms that can cause plant diseases.

d. Digested Slurry as a Supplement in Ration of Animal and Fish

Digested slurry has been used to supplement feed for cattle, poultry and fish in experimental basis. The encouraging results obtained from experiments are yet to be commonly practiced by the users. The following subsections describe various experiments carried out in this area.

e. Digested Slurry as a Feed to Animals

Results from the Maya Farms in the Philippines showed that in addition to the plant nutrients, considerable quantity of Vitamin Bi2 (over 3,000 mg of Bi: per kg of dry sludge) are synthesised in the process of anaerobic digestion. The experiment has revealed that the digested slurry from biogas plant provides 10 to 15% of the total feed requirement of some cattle, and 50% for ducks (Gunner son and Stuckey, 1986). Dried sludge could be substituted In cattle feed with satisfactory weight gains and savings of 50% in the feed concentrate used (Alviar. et al.. 1990). The growth and development of Salmonella chloreasuis and Coli bacillus were inhibited under anaerobic fermentation. The low availability of good quality forage is the result of low productivity of rangeland as well as limited access to it. Only 37% of rangelands arc accessible for forage collection (HMG/AsDB/ FINNIDA 1988). Therefore, addition of dried sludge in cattle feed would improve the nutrient value of the available poor fodder.

f. Digested Slurry as a Feed to Fish

A comparative study on fish culture fed only with digested chicken slurry was carried out by National Bureau of Environmental Protection (NBEP). Nanjing. China in 1989. The results showed that the net fish yields of the ponds fed only with digested slurry and chicken manure were 12,120 kg/ha and 3,412.5 kg/ha, respectively. The net profit of the former has increased by 3.5 times compared to that of the latter. This is an effective way to raise the utilization rate of waste resources and to promote further development of biogas as an integrated system in the rural areas (Jiayu, Zhengfang and Qiuha, 1989).



An experiment was carried out in Fisheries Research Complex of the Punjab Agricultural University, Ludhiana, India to study the effects of biogas slurry on survival and growth of common carp. The study concluded that growth rates of fish in terms of weight were 3.54 times higher in biogas slurry treated tanks than in the control. Biogas slurry proved to be a better input for fish pond than raw cow dung since the growth rate of common carp in raw cow dung treated tanks were only 1.18 to 1.24 times higher than in the control. There was 100% survival of fish in ponds fed with digested biogas slurry as compared to only 93% survival rate in ponds fed with raw cow dung.

g. Other Uses

Bioslurry has been extensively used to grow mushroom in household or commercial farms in different countries. Bioslurry Many extensive experiments performed in China have proved that the digested slurry, when used as fertilizer, has strong effects on plant tolerance to diseases

such as potato wilt (*Pseudomonas solanacearum*), late blight, cauliflower mosaic, etc. and thus can be used as bio-chemical pesticide.

A series of experiments and analyses conducted in China in a period of three years show that the cold-resistant properties of early season rice seedling are effectively enhanced by soaking seeds with digested slurry.

The survival rate increased by 8 to 13% and the quality of seedlings raised by soaking seeds with digested slurry is much higher than that of the control group during the recovering period after low temperature stress. The seedlings germinated faster, grew well and resisted diseases (Biogas Technology In China, 1989).



Foliar application of diluted slurry increases rate of wheat plant growth, resists to lodging and increases size of grains and length of the ear. Foliar application in grapes have been found to increase yield, length of fruit year, sugar content, fruit size, colour, and resistance to mildew diseases. In cucumbers, it has been observed to increase resistance to wilt diseases. In peach, it develops better fruit colour and early maturation.

Learning Units 8 and 9

Unit 7 - C8.3: Describe the roles and responsibilities of a biogas technician

Unit 8 - C8.4: Practice occupational health and safety measures

Topic-1: Role of Technician for Security and Safety Measures

When operating a biogas plant special attention has to be paid to avoid potential risks as described below:

- Breathing in biogas in a high concentration and over longer periods of time can cause poisoning and death from suffocation. The hydrogen sulphide content of biogas is highly poisonous. Non-purified biogas has a typical smell of rotten eggs. Purified biogas is odourless and neutral. Therefore, all areas with biogas operating appliances should be well ventilated. Gas pipes and fittings should be checked regularly for their gas-tightness and be protected from damage. Gas appliances should always be under supervision during operation. Everybody dealing with biogas, in particular children should be instructed well and made aware of the potential dangers of biogas.
- After emptying biogas plant for repair, it has to be sufficiently ventilated before entering into the digester. In this case the danger of fire and explosion is high (gas/air mixture!). The so-called chicken test (a chicken in a basket enters the plant before the person and if returns in good condition it guarantees sufficient ventilation) is advised to be conducted to ensure safety. While entering the digester. Make sure that there are at least two persons.
- Biogas in form of a gas-air mixture with a share of 5 to 12 % of biogas is a source of ignition and at higher temperatures it can easily explode. Danger of fire is high if the gas-air mixture contains more than 12 % of biogas. Smoking and open fire must therefore be prohibited in and around the biogas plant.
- The initial filling of a biogas plant poses a particular danger, when biogas mixes with large empty air-spaces. A farmer may want to use open fire/candle to check how full the plant is during the process of filling already and cause an explosion. **It should be avoided.**
- The digester of a biogas plant and the slurry storage facilities should be built in such a way that neither persons nor animals are in danger of falling into them.
- Moving and movable parts should have a protective casing to avoid catching persons or animals.
- Appliances operating on biogas normally have high surface temperatures. The danger of burning is high, in particular for children and strangers. A casing of non-heat-conducting material is advisable.
- The mantle of the gas lamp is radioactive. The mantle has to be changed with utmost caution. Especially the inhalation of crumbling particles must be avoided. Hands should be washed immediately afterwards.
- The piping system can become traps on the farm compound. As much as possible, pipes should be laid some 30 cm underground. Pits for water traps, gas meters, main valves or test-units should be covered by a concrete frame and covered with a heavy concrete lid.

General Instructions for Safety:

- Check regularly all the pipes, gas valves, equipment for any possible leakages. The leakage should only be checked with the foam of soap or shampoo; one can see

bubbles' size increase in case of leakages. NEVER TRY TO CHECK LEAKAGE WITH A FLAME.

- Never smoke cigarette or turn on fire near biogas installations, including biogas plant, fittings, generator, filters etc.
- Daily feed the biogas plant with recommended dose of fresh dung, for proper functioning of plant.
- Always keep an eye on the pressure shown in pressure gauge before and during usage of biogas
- Slurry pits should be emptied out once filled with slurry, to avoid stoppage of overflow or to avoid slurry going back in biogas plant.
- Avoid any heavy vehicle like tractor, trolley, or any other heavy weight of any kind on biogas plant to avoid any damage.
- Lubricate the valves on regular intervals to avoid malfunctioning or leakages.
- Shut the main valve after usage of biogas
- Regularly clear the over flow opening, because slurry adhered to it becomes dry and reduces the size of opening or sometimes blocks the opening.
- Always keep all the equipment including generator, filters, fittings, etc. clean from dust and moisture
- Never try to alter the order of equipment on your own.
- Never try to fix the leakages, or other damages yourself, always call the expert.
- Any damage to any equipment, biogas plant part, fittings, appliances due to unavoidable circumstance, climatic conditions, natural disaster, improper maintenance, not acting upon the instructions in this manual, will be purely responsibility of biogas plant owner and S/he will not claim any damages from Biogas Construction Company who constructed the plant.

Generator:

- Do not smoke near the generator or plant.
- Generator should be placed in the shade and protected from moisture/rain.
- As hot fume gases comes from the exhaust, the generator should be placed in ventilated area where fresh air circulates continuously.
- Keep generator away from fire and/or fire source.
- Keep generator away from inflammable things like petrol, kerosene oil, etc.
- Oil of generator should be checked regularly, if possible daily before operation.
- Check oil level indicator before each use and add correct oil type as instructed by the manufacturer or vendor.
- Oil of generator should be changed regularly as per manufacturer's instructions just reduce the interval between two oil changes by half.
- Do not run the generator when the oil level is low.
- Before turning on the generator, check all the electrical connections, i.e. power button on generator, it should be in OFF position.
- Similarly when turning off the generator, always turn the power button in OFF position, i.e. disconnect the generator from the power line.
- There should be a proper change over in the house for changing the electrical line (from wapda/national grid to generator or from generator to wapda/national grid).
- All the electric equipment should be of very good quality and made up of heat resistant materials.

- The connecting wire from generator to change over should be of good quality.
- Electrical connections should not be loose, otherwise sparking would cause fire.
- Generator battery should be checked regularly and follow the instructions of manufacturer for its up keep.
- Check for any overflow or leakages and also check the battery water level.
- Do not turn on the generator when the gas pressure is low.
- Turn off the generator when gas pressure is low.
- When turning off the generator, always close the gas valve first.
- Disconnect generator from power supply during maintenance and/or repair.
- Do not touch generator with wet hands to prevent risk of electric shock.
- Do not attempt to touch mechanical parts when the generator is running, to avoid risk of injury.
- Do not allow children to touch the generator. Do not ask them to run it.
- Do not allow persons having not enough knowledge about generator or its operation to operate it.
- **Generator Filter Maintenance:** Air filter should be checked and cleaned on regular basis as per manufacturer's instructions or physical observations.
- Clean it with cleaning agent in every 50 hours. If it is too dusty, clean it in every 10 hours. After it is fully dry, insert it into clean oil. Use it when surplus oil is removed.

Starting Instructions:

- Fill with oil and gasoline before starting.
- Check oil level before every use.
- Disconnect any electric device.
- Open the fuel valve to OPEN position.
- Move choke lever to CLOSE position.
- Start the engine.
- Move choke lever to OPEN position after engine starts.

Storage Instructions:

- Drain the oil from the crankcase.
- Drain gasoline from tank completely, then loosen the drain bolt of carburettor and drain the fuel in carburettor.
- Store the unit in cool and dry place, avoid direct sunlight.
- Keep it away from children.

Petter Engine:

- Keep engine in a proper ventilated area to avoid any accident.
- Do not smoke near the Petter engine.
- Oil of Petter engine should be changed regularly as per manufacturer's instructions
- Use good quality of oil in Petter engine.
- Ensure continuous supply of water for Petter engine.
- Check Petter engine regularly.
- Over-hauling of Petter engine should be done after every 6 months.
- Always start the Petter engine on diesel, and then substitute it with biogas.
- Do not run the Petter engine when the gas pressure is too low.
- When turning off the Petter engine, always close the gas valve first.

- Do not allow children to touch the Petter engine while in operation or ask them to operate it.
- Do not allow persons having not enough knowledge about Petter engine or its operation to operate it.
- The usual range of fuel mixture, 70(gas):30(diesel) to 75(gas):25(diesel) ratio. The ratio can vary case to case depending upon the condition and age of petter engine, the quantity of load, size of engine, etc. sometimes the ration can even reduce to 50:50 due to poor maintenance of engine.

Dynamo:

- Do not run the dynamo continuous for longer period of time.
- Do not put the entire load on a single face; otherwise the dynamo will be damaged.
- Do not overload the dynamo.
- To avoid overloading use an ampere meter, so that it wouldn't cross the load limit.
- Maximum load of 9 kW can be put on dynamo having capacity of 12 kW.
- Do not touch dynamo with wet hands to prevent risk of electric shock.
- Check all the electrical connections every time before turning on the dynamo.
- Electric wire used for electricity should be of good quality.
- Electrical connections should not be loose otherwise sparking would cause fire.
- Keep children away while the dynamo is being used.
- Do a regular checking and maintenance of dynamo.

Filters:

- Place filters in suitable place, preferable under shade.
- Do not smoke or lit any fire near the filters.
- Filters pipe setting and welding joints should be checked regularly for any leakages. The leakage should only be checked with the foam of soap or shampoo; one can see bubbles' size increase in case of leakages. NEVER TRY TO CHECK LEAKAGE WITH FLAME.
- Water of CO₂ scrubber should be changed at least once in a month, earlier the better. Ensure that the water is safely disposed.
- Water level in CO₂ scrubber should be checked regularly and always maintain its level up to the marked point.
- Oil in H₂S filter has to be changed at least once in every two months. Ensure that the oil is safely disposed.
- Filter media in H₂S filter have to be regenerated (dry in sunlight) at least once in every two months.
- Silica Gel in moisture filter should be dried in sunlight at least once in every month.
- Oil level in H₂S filter should be checked regularly and always maintain its level up to the marked point.
- Do not exceed or decrease the water/oil level from the marked point in CO₂ scrubber and H₂S filter, just maintain its level up to the marked point.
- At least 2 kg of Silica Gel should be filled in moisture filter for 50 cubic meter plant, and 3 kg for 100 cubic meter plant.

Self-Assessment Questions for Participants

The participants of the training/course should assess themselves at the end of the training sessions/course designed for this module. The following probe-questions could be used as guidance for self-assessment process:

SN	Self-assessment Questions
1	What are the major operational activities needed to operate a biodigester trouble-free? Why does a stove burn with yellow flame?
2	What happens if the biodigester is under-fed or over-fed?
3	What happens if the water drain is not operated properly?
4	What is scum? Why does it form? How to avoid scum formation?
5	What is the reason for an intermittent explosive sound in the generator after initiation?
6	How to solve a problem of slurry entering into the gas pipeline?
7	What are the major uses of biogas?
8	What are different methods of using bioslurry in the farm?
9	Why is bioslurry better than conventional farm yard manure?
10	What is the importance of routine monitoring of functioning of a biodigester? What are some of the monitoring parameters?
11	What are the safety measures while starting and operating a Petter Engine?
12	What is the quantity of biogas needed to operate a 10 horse power diesel engine for 4 hours?

Final Assessment of Competencies

Candidate's Name			
Assessor's Name			
Course Title	Training of Biodigester Technicians (Masons) to Construct Fixed Dome Biodigester for Running Pumps		
Brief description of required competency	Enhanced knowledge and skills of a would-be technical supervisor (i) to construct quality biodigesters, and (ii) to ensure continued operation of the installed facility, so that the users are benefitted for long run.		
Date of Assessment			
Competency Expected	Yes	No	Comments
Recall basic concepts of biogas production and benefits of biodigester technology	<input type="checkbox"/>	<input type="checkbox"/>	
Read and interpret drawings of fixed dome biodigesters	<input type="checkbox"/>	<input type="checkbox"/>	
Select suitable type and appropriate size of fixed dome biodigester and carry out basic calculations	<input type="checkbox"/>	<input type="checkbox"/>	
Select construction materials and construction site	<input type="checkbox"/>	<input type="checkbox"/>	
Construct structural components of a fixed dome biodigester	<input type="checkbox"/>	<input type="checkbox"/>	
Install pipeline, appliances and electro-mechanical components	<input type="checkbox"/>	<input type="checkbox"/>	
Perform routine operation and minor maintenance tasks	<input type="checkbox"/>	<input type="checkbox"/>	
Practice quality norms and ensure the compliance of quality standards while construction	<input type="checkbox"/>	<input type="checkbox"/>	
The candidates performance is:	Competent <input type="checkbox"/>	Not yet competent <input type="checkbox"/>	Comments:
This signature confirms candidate's agreement that the above record is a true reflection of the tasks performed.			
Signature of the Candidate:		Date:	
This signature confirms that the candidate has demonstrated competence in the theoretical understanding and practical performance and of the observed tasks.			
Signature of the Assessor:		Date:	

Annexes

Annex-1: Monitoring Parameters for fixed-dome Biodigester

SN	Parameter	Frequency	Equipment	Monitoring
1	Quantity of cattle-dung	Daily at set times (end of afternoon?)	Bucket, weighing scale	Initially daily by Project technician, later perhaps by hh
2	Quantity of water	Daily at set times (end of afternoon?)	Bucket	Initially daily by Project technician, later perhaps by hh
3	Mixing of dung and water	Daily at set times (end of afternoon?)	Visual	Initially daily by Project technician
4	Biogas consumption	Continuous	Gas flow meter, Sulphur filter	Initially daily by PROJECT technician, later less
5	Digester temperature	Daily at set times, fixed position	Min-max thermometer (or more advanced?)	Daily by PROJECT technician / continuous
6	Ambient temperature	Daily at set times, fixed position	Min-max thermometer (or more advanced?)	Daily by PROJECT technician / continuous
7	pH	Weekly at set point; before feeding, in the digester, in the outlet discharge point	pH meter, litmus paper	Weekly by PROJECT technician
8a	Max gas pressure before and after the filter	Daily in the morning, before first gas consumption	Pressure meter	Daily by PROJECT technician, later perhaps by hh
8b	Max outlet slurry level	Daily in the morning, before first gas consumption	Measurement stick, measuring tape	Daily by PROJECT technician, together with pressure. Later perhaps by hh
9a	Min gas pressure before and after the filter	Daily in the evening, after last gas consumption	Pressure meter	Daily by PROJECT technician, together with pressure. Later perhaps by hh
9b	Min outlet slurry level	Daily in the evening, after last gas consumption	Measurement stick, measuring tape	Daily by PROJECT technician, together with pressure. Later perhaps by hh
10	Percentage of Methane before and after the filtration	Once in a week	Biogas Analyser	Weekly by PROJECT technicians
11a	Generator/Engine running hours	Daily	Clock	Initially daily by PROJECT technician, later by hh.
11b	Biogas stove-use	Daily	Clock	Initially daily by

	hours			PROJECT technician, later by hh.
11c	Biogas lamp-use hours	Daily	Clock	Initially daily by PROJECT technician, later by hh.
12a	Closing of main valve	Daily in the evening, after last gas consumption	Clock	Initially daily by PROJECT technician, later by hh.
12b	Opening of main valve	Daily in the morning, before first gas consumption	Clock	Initially daily by PROJECT technician, later by hh.
13a	TS and VS fresh dung	Twice for each plant, after process is stabilized (three months operation)	Containers, oven, weighing scale, simple lab equipment	By research institute, laboratory
13b	TS and VS slurry in outlet	Twice for each plant, after process is stabilized (three months operation)	Containers, oven, weighing scale, simple lab equipment	By research institute, laboratory
14	Water tightness	In sampled plant. Once upon commissioning and once at the end of the testing period	Lots of water, measuring tape. Details on Biogas Technology Manual	By PROJECT Technical Officers
15	Gas tightness	For each plant. Once upon commissioning and once at the end of the testing period	Lots of water, measuring tape, pressure gauge. Details on Biogas Technology Manual	By PROJECT Technical Officers
16	Sediment and scum content	Each plant to be checked, at the end of the testing period	Buckets, visual, weighing scale, camera, folding rod	By PROJECT Technical Officers
17	Daily Biogas Production	At least once in a month for 12 months	Measuring tape, visual, gas flow meter	By PROJECT Technical Officers in the beginning and later by local technicians

Annex-2: Tools and Equipment

Routine Monitoring Tools

(a) Measuring Tape – 5m long



Used for measuring different components of biodigester.

(b) Pressure Meter (Digital or analogue)



Used to measure gas pressure and detect leakages in the

(c) pH Meter



To measure the pH (acidity and alkalinity) level of the influent and effluent.

(d) Digital Thermometer



To measure/monit or temperature (ambient and various locations inside the

(e) GPS Receivers



To locate the exact locations of bioreactors.

(f) Plier



(g) Screw Driver



(h) Pipe Wrench



Specialised Monitoring Tools

(a) Biogas Analyser



(b) Bioslurry Sampler

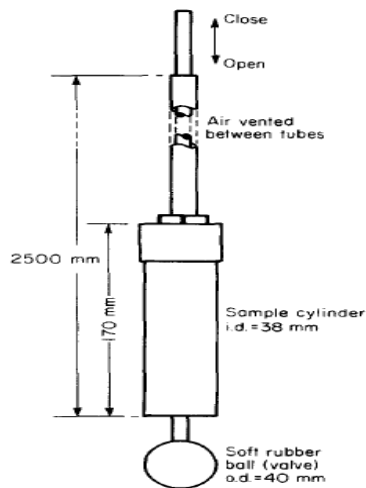

To facilitate measurement of different components of filled biodigesters

(c) Folding Pipe



(d) Foot Pump or Bicycle Pump

To assess the performance of filtration system by measuring the percentage of methane and



(e) Biogas Flow Meter



To check leakages through gas holders, pipelines and appliances.

To measure the quantity of biogas consumed by a specific end use applications such as

Annex-3: Session Plan -Training of Technicians - Fixed Dome Biodigesters

Time	Topic	Methodology	Training Aids	Expected Outcome
Day-1				
8:00-9:00	Registration, Introduction of participants and instructors. Objective and schedule of training and Pre-test.	Registration, Classroom presentation	Register, Training Manual, Presentation slides	All participants are listed. Participants know each other and their instructors. Participants know the course objective. The instructors know the level of understanding of participants.
9:00-10:30	Introduction to technology – Ideal condition for gas production	Classroom presentation	Presentation slides, Videos	Participants know the basic concepts of biogas production, ideal conditions for biogas production and prerequisites for installation of biodigesters
10:30-12:00	Types and Functioning of biodigesters	Classroom presentation	Drawings of a biogas plant Model of Biodigester, Presentation slides	Participants know different types of biodigesters, comparative merits and demerits. They will be familiar with the functioning of biodigesters.
12:00-13:00	Introduction to different parts of a biodigesters	Classroom presentation	Model of Biodigester, Presentation slides, 3D drawings	Participants know different components of biodigester and their interrelations
13:00-14:00	Lunch			
14:00-15:00	Benefit of Biodigesters and importance in Pakistan	Classroom presentation	Presentation slides, Videos	Participants know the benefits of biodigester at the household, community and macro levels. The know why biodigesters are important for Pakistan
15:00-16:45	Basic Concept of drawing	Class room presentation	Objects of different shapes, Presentation slides	Participants know basic concepts of drawings and are familiar with plan, section, elevation and isometric views
16:45-17:00	Recapitulation of the day	Discussions	Flip chart, white board, marker pens	Participants will be able to recall the learning of the day.
Day-2				
08:00-12:00	Reading and interpretations of drawing of biogas plant	Class room presentation, practical drawing	Laminated drawing with measurement, Model of a biodigester	Participants know methods to do correct measurements of different plant-components, and be able to identify plan and section projections drawings of biodigesters.
12:00-13:00	Lunch Break			
13:00-13:45	Correct size selection of a biogas plant.	Classroom presentation	Presentation slides, Construction manual	Participants know how to calculate amount of dung required for different plants and be able to advise to select suitable size of biodigesters.
13:45-14:30	Quality of Construction Materials	Classroom, Presentation and	Presentation slides, Construction	Participants are familiar with quality standards of construction material and effect of sub-standard quality of

		demonstration	manual, bottle, const. materials	materials on durability/functioning of a biodigester.
14:45-15:30	Construction Site Selection	Classroom presentation	Construction manual, photos, Video	Participants are able to select proper site for plant construction. E.g. minimum distance from water source and stable, sunny place etc.
15:30-16:45	Overview of construction of biodigesters	Classroom presentation/ Video show	Construction Manual, Video/DVD	Participants are able to internalise various steps of construction of biodigesters.
16:45-17:00	Recapitulation of the day	Discussion	Flip chart, white board, marker pens, meta cards	Participants will be able to recall the learning of the day.
Day-3				
8:00-10:30	Layout, Digester Construction / Inlet and toilet pipe connection	Class room presentation / Video show	Slides, Construction manual, Video	Participants are familiarised with the construct of main digester following and the procedures as mentioned in the construction manual.
10:45-12:45	Dome construction / dome treatment	Class room presentation / Video show	Slides, Construction manual, Video	Participants are able to tell the correct procedures of dome construction as specified in the construction manual.
12:45-13:30	Lunch Break			
13:30-14:00	Outlet construction	Class room presentation / Video show	Slides, Construction manual, Video	Participants are able to tell the correct procedures of outlet construction as specified in the construction manual.
14:00-14:30	Slab casting	Class room presentation / Video show	Slides, Construction manual, Video	Participants are able to tell the correct procedures of outlet slabs construction as specified in the construction manual.
14:45-15:45	Inlet construction	Class room presentation / Video show	Slides, Construction manual, Video	Participants are able to tell the correct procedures of inlet construction as specified in the construction manual.
15:45-16:30	Pipeline/appliances fitting	Class room presentation / Video show	Slides, Construction manual, Video	Participants are able to tell the correct procedures of pipeline fitting with minimum joints.
16:30-17:00	Construction of Compost pit	Class room presentation / Video show	Slides, Construction manual, Video	Participants are able to advise farmers on digging correct size compost pits.
17:00-17:15	Recapitulation of the day	Discussion	Flip chart, white board, marker pens, meta cards	Participants will be able to recall the learning of the day.
Day-4				
Whole day	Construction of foundation and round walls of digester	Practical exercise	Construction materials for on-the-job work, construction tools	The participants know: <ul style="list-style-type: none"> • The centre of digester should carefully be fixed and central pole should tightly be secured. The pole should be vertical. • Radius of digester should be selected as per the drawing

				<ul style="list-style-type: none"> • The distance between the centre of the pole to end of chord or string should be equal to radius of digester plus 15 mm for plaster. • Mortar ratio for wall construction should be – 1:4 and that of PCC is 1:3:6. • Bricks/stones should be soaked in water before using • Each brick/stone has to be laid by matching its side (rise) with the chord/string fixed on the centre pole. • Joints between brick/stones should be well compacted. Joints in adjacent layer should not fall in a vertical line. • The lowest point of inlet pipe should be 35 cm above the floor • The cavity in the back of the wall should be filled properly
Day-5				
Whole day	Construction of Round wall	Practical exercise, on the-job work	Construction materials for on-the-job work, construction tools	<ul style="list-style-type: none"> • Same as day 4
Day-6				
Whole day	Plastering of Round wall	Practical exercise	Construction materials for on-the-job work, construction tools	<p>The participants know:</p> <ul style="list-style-type: none"> • The soil should be well compacted before start floor construction • The floor of digester should be constructed with broken bricks or stone and thick plaster of 1:4 ratio • The walls and floor of digester should be plaster with smooth surface – mortar ratio 1:3 (cement: sand)
Rest Day				
Day-7				
Whole day	Preparation of formworks for dome casting (earthen mould or scaffolding) and fixing of reinforcements	Practical exercise	Construction materials for on-the-job work, construction tools	<p>The participants know:</p> <ul style="list-style-type: none"> • Care should be provided to fill in the earth to avoid damage to round wall • Soil mould should be compacted well • Use of correct size of template is necessary • Proper use of template is essential • If metal or wooden framework is

				<p>to be used, care should be provided that it is strong enough and safe</p> <ul style="list-style-type: none"> • The finished surface of the mould should be sprinkled with water and covered with a thin layer of sand before concreting. • The re-bars should be of 10 cm dia arranged as specified in construction manual
Day-8				
Whole day	Complete the fixing of reinforcement bars and casting of dome, outlet cover and water drain cover	Practical exercise	Construction materials for on-the-job work, construction tools	<p>The participants know:</p> <ul style="list-style-type: none"> • The mix of mortar for casting of dome should be 1:2:4 (cement:sand:aggregate) • The work of concreting should start from on edge and continue to the opposite edge via the top • The depth of concrete should be as per drawing • Freshly laid concrete should be properly compacted • The mortar should be used within 30 minutes from its preparation • Concreting works should be done uninterruptedly • Dome gas pipe should be correctly placed in the centre of the dome • The finished surface should be properly cured for at least five days. • Outlet and water drain cover should be casted as per instruction in construction manual
Day-9				
08:00-09:00	Sharing of field experiences	Discussions, Classroom presentation	Flip chart, white board, marker pens, meta cards	The participants share experiences from the field; problems encountered, solutions applied and way forward
09:00-12:30	Introduction to Biogas filtration methods	Classroom Presentation and Demonstration	Presentation slides, sample of filters	<p>Participants will be familiar with:</p> <ul style="list-style-type: none"> • Fabrication process of filters • Installation process of CO₂ scrubber • Installation process of H₂S remover • Installation process of Moisture remover • Recharging methods of filter media
12:30-13:30	Lunch			
13:30-14:15	Modification of gasoline	Classroom	Presentation	Participants will be aware of the

	and petrol engines to operate with biogas	Presentation and Demonstration	slides, sample of engines	need of some modification in conventional engines to operate with biogas.
14:15-15:00	Use of biogas for operating dual fuel engines and generators	Classroom Presentation and calculation exercise	Presentation slides, engines	Participants will know the gas requirements and application of biogas to operate engines.
15:00-17:00	Visit to filter manufacturing workshop	Demonstration and observation	Mechanical workshop, tools and equipment	Participants will observe the process of manufacturing of filter systems, filling of filter media and other aspects of manufacturing
Day-10				
8:00-10:30	Major operational activities	Classroom Presentation and Demonstration	O & M manual, biogas appliances	Participants will be able to realize the importance of proper O&M
10:30-13:00	Routine maintenance activities	Classroom Presentation and Demonstration	O & M manual, biogas appliances, maintenance tools	Participants will acquainted with basic knowledge on carrying out routine O&M activities
13:00-14:00	Lunch			
14:00-15:00	Potential problems and likely solutions	Classroom Presentation and Demonstration	O & M manual, biogas appliances	Participants will be able to identify the potential problems and suggest likely solutions
15:00-16:30	Dos and Don'ts	Classroom Presentation and Demonstration	O & M manual, biogas appliances	Participants will be familiar with the factors that lead to long term trouble free functioning of biodigesters
15:30-17:00	Recapitulation of the day	Discussion	Flip chart, meta cards, white board, marker pens	Participants will be able to recall the learning of the day.
Day-11				
08:00-09:30	Need for and importance of quality assurances	Class room presentation	Construction and O&M Manuals, QC handbook	Participants will be aware of the importance of QC and know the basic quality standards
09:30-11:30	Case presentation	Case presentation and discussion	Failure and success cases, meta cards, marker pens	Participants will realise the importance of quality assurance from failure and success cases
11:30-13:00	Quality standards and tolerance limits	Class room presentation, demonstration	Construction and O&M Manuals, QC handbook	Participants will have knowledge on quality standards to be complied during installation of biodigester.
13:00-14:00	Lunch Break			
14:00-15:00	Forms and formats for quality monitoring	Class room presentation, demonstration	QC forms and formats	Participants will be familiar with the QC forms and formats.
15:00-16:00	QC process and data management	Class room presentation,	Database sample,	Participants will be familiar with overall process of quality control,

		demonstration	Presentation slides	data collection process and data management system
16:00-16:45	Roles and Responsibilities of Masons and Supervisors for quality assurance	Class room presentation	Construction and O&M Manuals	Participants will be able to realize their roles and responsibilities on promotion, extension, construction and O&M of biogas plants
16:45-17:00	Recapitulation of the day	Discussion	Flip chart, meta cards, white board, marker pens	Participants will recall the learning of the day.
Day-12				
08:00-09:30	Optimisation of the use of biogas – diversification of end use applications	Presentation, discussion	Presentation slides	Participants will be familiar with various end use applications and methods to optimally use biogas.
09:30-10:30	Characteristics of bioslurry - Bioslurry vs. Farm Yard Manure (FYM)	Presentation	Presentation slides	Participants will know the basic characteristics of bioslurry – with special focus on nutrient contents and they will be familiar with the advantages of bioslurry over conventional farm yard manure
10:30-11:30	Proper uses of bioslurry – storing, handling, application	Presentation	Presentation slides	Participants will learn various aspects of bioslurry use – storing, handling, application
11:30-13:00	Video on application of bioslurry	Class room presentation / Video show	Slurry Manual, Video	Participants will learn various aspects of bioslurry – storing, handling, application from the visual aid
13:00-14:00	Lunch			
14:00-15:00	Critical points that has to be taken consideration while commissioning biogas plants	Class room presentation, discussion	Presentations slides, case story	The participants will be acquainted with the critical points in which special consideration has to be given while construction and installation
15:00-16:30	Common mistakes in biogas plants construction	Class room presentation, discussion	Presentations slides, case story	The participants will know the common mistakes made while construction and installation and prepare for avoiding such mistakes
16:30-17:00	Recapitulation of the day	Discussion	Flip chart, meta cards, white board, markers	Participants will be able to recall the learning of the day.
Rest Day				
Day-13				
Whole day	<ul style="list-style-type: none"> • Excavation work for outlet tank • Turret construction • Inlet construction 	Practical exercise, On-the-job work	Construction materials for on-the-job work, construction tools	<p>The participants will learn the following:</p> <ul style="list-style-type: none"> • Excavation should start only after the construction of manhole • The length, breadth and depth of excavation should be as per the construction manual • Care should be provided not to dig more than needed

				<ul style="list-style-type: none"> • Turret has to be constructed as shown in the drawing to protect main gas pipe against any damage • The foundation of the inlet pit should be placed in well rammed, hard and levelled surface. • In this rammed surface first of all the rectangular base of inlet tank is constructed. • The height of the base should be decided in such a manner that the floor of inlet tank is at least 15 cm above the outlet overflow level. • Height of inlet walls should not be more than 1m from the ground level • The drain from cattle shed should facilitate easy flow of feeding to the digester • The mixing machine should be fitted properly to facilitate easy and effective mixing of water and dung
Day-14				
Whole day	<ul style="list-style-type: none"> • Removing of formwork used for dome casting • Construction of Inlet completes. 	Practical exercise, On-the-job work	Construction materials for on-the-job work, construction tools	Participants will learn that: <ul style="list-style-type: none"> • The framework needs to be removed carefully to avoid accident • The inlet has to be complete with a plastering of 1:3-4 cement sand mortar.
Day-15				
Whole day	<ul style="list-style-type: none"> • Removing of formwork and cleaning of inside of dome 	Practical exercise, On-the-job work	Construction materials for on-the-job work, construction tools	Participants will learn that: <ul style="list-style-type: none"> • The inner surface of dome should be chiselled and clean well with water before starting plaster work
Day-16				
Whole day	<ul style="list-style-type: none"> • Construction of manhole • Construction of outlet foundation/floor 	Practical exercise, On-the-job work	Construction materials for on-the-job work, construction tools	Participants will learn that: <ul style="list-style-type: none"> • The manhole walls should be centred with 1:4 cement sand mortar. • The wall should be vertical with no overlapping of joints in adjacent layers • The base of outlet tank should be prepared with broken bricks/stones and a thick layer of plastering • The foundation should be concreted with 1:3:6 PCC.

Day-17				
Whole day	<ul style="list-style-type: none"> Construction of outlet walls 	Practical exercise, On-the-job work	Construction materials for on-the-job work, construction tools	Participants will learn that: <ul style="list-style-type: none"> The length, breadth and height of outlet should be as per the drawing The manhole walls should be centred with 1:4 cement sand mortar. The overflow opening should be in the longer wall parallel to the hart-line The overflow opening should be built slightly higher than the ground level (as per the drawing) to avoid water entering into the outlet during rainy season.
Day-18				
Whole day	<ul style="list-style-type: none"> Outlet construction continues. Inside plastering of dome (1st and 2nd layers) 	Practical exercise, On-the-job work	Construction materials for on-the-job work, construction tools	Participants will learn that: <ul style="list-style-type: none"> In the chiselled surface of dome, a thin layer of cement-water solution applied with broom Then, a layer of plaster (1:3), 12 cm thick has to be applied. The surface of plastering should be smooth and fine.
Rest Day				
Day-19				
Whole Day	<ul style="list-style-type: none"> Plastering of Outlet Inside plastering of dome (3rd layer) 		Construction materials for on-the-job work, construction tools	Participants will learn that: <ul style="list-style-type: none"> The plastering of outlet should be done in 1:4 cement sand mortar. The plastered surface should be smooth and well finished. A thin layer (5 mm) of cement-sand punning (1:2) to be applied once the second layer is set.
Day-20				
	<ul style="list-style-type: none"> Installation of Gas Filtration system Inside plastering of dome (4th layers) 	Classroom presentation and Practical exercise (On-the-job work)	Filter system, construction tools	<ul style="list-style-type: none"> CO₂ scrubber, H₂S removal and moisture removal installed 1 part of Acrylic emulsion paint has to be well mixed with 10 parts of cement by volume adding required quantity of water to make fine paste. This paste should be applied evenly throughout the surface of dome (3-5 mm thick)
Day-21				
Whole day	<ul style="list-style-type: none"> Pipeline works 	Practical exercise, On-the-job work	Pipes and fittings, plumbing tools and equipment	Participants will learn that: <ul style="list-style-type: none"> Select the shortest and safe alignment for gas pipe Avoid too many joints and bends Water drain pit must be

				<p>constructed at the lowest point of the pipe line where it is easily accessible. When finished, the inside dimension must be 40 X 40 cm and the height 50 cm. To avoid rain water entering into the drain pit the walls must be at least 5 cm above ground level. For easy operation of the water drain it must be installed 30 cm below the ground level. The drain pit slab has to be of 66 X 66 cm and easy to handle by 1 person.</p> <ul style="list-style-type: none"> • To avoid gas leakage Teflon tape must be used to seal every joint. • One must minimise using unnecessary fittings and unions in the pipe line. • No unnecessary fittings should be used in between the reducer of dome gas pipe and the main valve. • To prevent it from damage the pipeline must be buried 30 cm where possible.
Day-22				
Whole day	<ul style="list-style-type: none"> • Finishing of Inside plastering of dome (5th layer) 	Practical exercise, On-the-job work	Construction materials for on-the-job work, construction tools	<p>Participants will learn that:</p> <ul style="list-style-type: none"> • 1 part of Acrylic emulsion paint has to be mixed with 2 parts of cement by volume with required quantity of water to make fine paste • This paste should be applied evenly throughout the surface of dome (2 mm tick) with the brush
Day-23				
Whole Day	Construction of Slurry collection (Compost) pit, finishing works	Practical Exercise. On-the-job work	Construction materials for on-the-job work, construction tools	<p>Participants will learn that:</p> <ul style="list-style-type: none"> • The compost pit must be minimum 1 m away from the outlet walls where the slurry can flow into the pit by gravity. • 2 compost pits equivalent to the plant volume must be made. • The depth of the compost pits must not exceed more than 1m and the distance between the two compost pits must not be more than 50 cm. • The length and width at the top must be more than of the bottom (trapezoidal shape) and add 10 cm mud on all sides to raise the height from the ground level to

				avoid rain water entering the compost pits. <ul style="list-style-type: none"> • Cover the entire dome with at least 30 cm thick layer of soil • Clean the site properly
Day-24				
08:00-9:30	Recapitulations of the whole training programme	Discussion	Flip chart, white board, meta cards, markers	<ul style="list-style-type: none"> • The participants will share their experiences, and learning from the training
9:30-10:00	Questions and answers	Discussions/written questions and answers	Flip chart, white board. Meta cards, marker pens	<ul style="list-style-type: none"> • The participants will put forward any questions and queries – verbally or in writing for discussions
10:00-13:00	Assessment of trainees	Written and verbal tests, simulation situation, interviews	Questionnaires, interview guidelines, case for simulation	<ul style="list-style-type: none"> • The participants will be assessed using the standard assessment protocol to evaluate the learning and award the certificate.
13:00-14:00	Lunch			
14:14:30	Training evaluation	Answering of questionnaires	Evaluation questionnaire	<ul style="list-style-type: none"> • The participant will provide their comments, suggestions and feedback on the whole training process.
14:30-15:30	Certificate distribution and closing		Certificates	<ul style="list-style-type: none"> • Candidate will be awarded with the certificate of completion.

Note:

(i) Layout work in the on-the-job venue should be done prior to the start of training so that excavation work will be completed before the start of the on-the-job training on the fourth day of the training.

(ii) The trainer should manage time for tea breaks in the morning and afternoon sessions based upon time availability

Annex-4: Abbreviations Used in the Text

BCC	- Biodigester Construction Company
CBO	- Community Based Organisation
CER	- Certified Emission Reduction
CI	- Compression Ignition
C/N	- Carbon Nitrogen Ratio
COD	- Chemical Oxygen Demand
FYM	- Farm Yard Manure
GGC	- Gobar Gas (Biogas) Company
GI	- Galvanised Iron
GPS	- Global Positioning System
HDPE	- High Density Poly Ethylene
HP	- Horse Power (746 watts)
HTR	- Hydraulic Retention Time
KJ	- Kilo Joule
KN	- Kilo-Newton
KVIC	- Khadi and Village Industries Commission (India)
kWh	- Kilo Watt Hours
LPG	- Liquefied Petroleum Gas
MJ	- Mega Joule
MS	- Mild Steel
NAVTTTC	- National Vocational and Technical Training Commission
NPK	- Nitrogen, Phosphorus, Potassium
NTP	- Normal Temperature and Pressure
O&M	- Operation and Maintenance
PCC	- Plain Cement Concrete
PCRET	- Pakistan Centre for Renewable Energy Technology
PKR	- Pakistani Rupees (1 US\$ = PKR 100, in January 2015)
PSDF	- Punjab Skill Development Fund
Psi	- Pound per Square Inch (Pressure)
PVC	- Poly Vinyl Chloride
QC	- Quality Control
QMS	- Quality Management System
RCC	- Reinforced Cement Concrete
RPM	- Revolutions per Minute
SI	- Spark Ignition
SNV	- Netherlands Development Organisation
STP	- Standard Temperature and Pressure
TVET	- Technical and Vocational Education and Training
TEVTA	- Technical Education and Vocational Training Authority
TS	- Total Solid
VER	- Verified Emission Reduction
VS	- Volatile Solid

National Vocational and Technical Training Commission (NAVTTTC)

 5th Floor Evacuee Trust Complex Sector F-5/1, Islamabad.

 +92 51 9044 04

 +92 51 9044 04

 info@navttc.org

 www.navttc.org