



Co-funded by the European Union



german cooperation
DEUTSCHE ZUSAMMENARBEIT



Norwegian Embassy
Islamabad



LEATHER PROCESSING TECHNOLOGIST

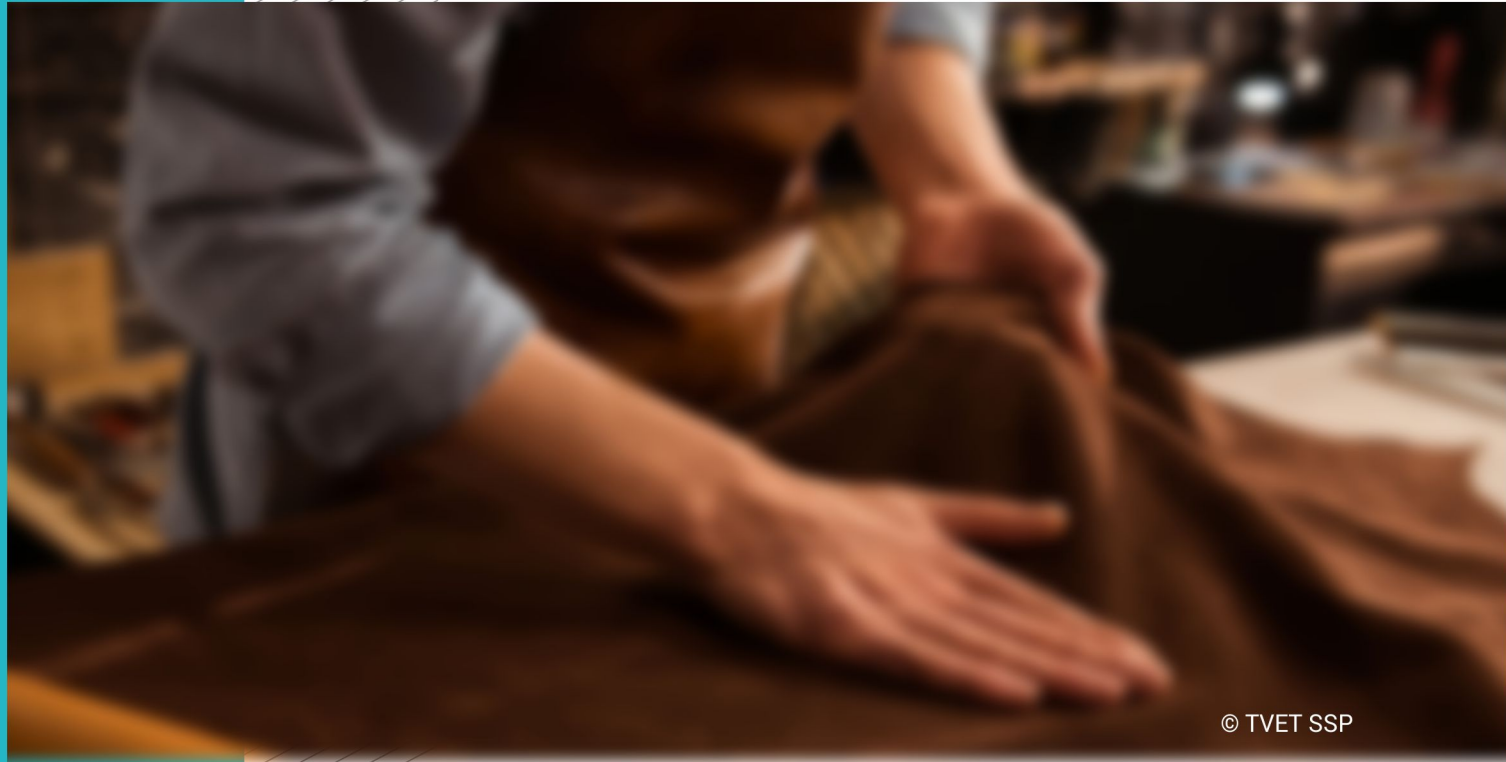

© TVET SSP

LEARNER GUIDE

National Vocational Certificate Level 2

Version 1 - September, 2019



Implemented by
giz Deutsche Gesellschaft
für Internationale
Zusammenarbeit (GIZ) GmbH

Published by

National Vocational and Technical Training Commission
Government of Pakistan

Headquarter

Plot 38, Kirthar Road, Sector H-9/4, Islamabad, Pakistan
www.navttc.org

Responsible

Director General Skills Standard and Curricula, National Vocational and Technical Training Commission
National Deputy Head, TVET Sector Support Programme, Deutsche Gesellschaft für Internationale Zusammenarbeit (GIZ) GmbH

Layout & design

SAP Communications

Photo Credits

TVET Sector Support Programme

URL links

Responsibility for the content of external websites linked in this publication always lies with their respective publishers. TVET Sector Support Programme expressly dissociates itself from such content.

This document has been produced with the technical assistance of the TVET Sector Support Programme, which is funded by the European Union, the Federal Republic of Germany and the Royal Norwegian Embassy and has been commissioned by the German Federal Ministry for Economic Cooperation and Development (BMZ). The Deutsche Gesellschaft für Internationale Zusammenarbeit (GIZ) GmbH in close collaboration with the National Vocational and Technical Training Commission (NAVTTTC) as well as provincial Technical Education and Vocational Training Authorities (TEVTAs), Punjab Vocational Training Council (PVTC), Qualification Awarding Bodies (QABs) and private sector organizations.

Document Version

September, 2019

Islamabad, Pakistan

LEATHER PROCESSING TECHNOLOGIST



© TVET SSP

LEARNER GUIDE

National Vocational Certificate Level 2

Version 1 - September, 2019

Introduction

The Leather industry is a highly labour intensive industry; labour is extensively employed in the initial stages of the Leather tanning process while greater skills are required at the finishing stage. This Course is designed to focus the need, importance and understanding of Leather tanning & processing industry as per the current competitive environment. Companies can maintain a strategic competitive advantage and produce more valued goods after better processing of leather. Increasing demand for skilled, efficient and effective employees has created demand for this course.

This course will enable functional and technical skills for leather processing technologist. The material is taught as leather processing mechanical operator, tanning technician, leather processing & finishing and quality perspective with an emphasis on where and how specific tools can be used to improve the overall performance in the leather processing.

The main elements of your learner's guide are:

- **Introduction:**
 - This includes a brief description of your guide and guidelines for you to use it effectively
- **Modules:**
 - The modules form the sections in your learner's guide
- **Learning Units:**
 - Learning Units are the main sections within each module
- **Learning outcomes:**
 - Learning outcomes of each learning units are taken from the curriculum document
- **Learning Elements:**
 - This is the main content of your learner's guide with detail of the knowledge and skills (practical activities, projects, assignments, practices etc.) you will require to achieve learning outcomes stated in the curriculum
 - This section will include examples, photographs and illustrations relating to each learning outcome
- **Summary of modules:**
 - This contains the summary of the modules that make up your learner's guide
- **Frequently asked questions:**
 - These have been added to provide further explanation and clarity on some of the difficult concepts and areas. This further helps you in preparing for your assessment.
- **Multiple choice questions for self-test:**
 - These are provided as an exercise at the end of your learner's guide to help you in preparing for your assessment.

LEATHER PROCESSING TECHNOLOGIST



© TVET SSP

Module-5
LEARNER GUIDE
National Vocational Certificate Level 2

Version 1 - September, 2019

Modules

Module 5: Carryout Fleshing

Objective of the module: The aim of this module to develop advanced knowledge, skills and understanding to carryout fleshing

Duration: 40 Hours **Theory:** 8 Hours **Practical:** 32 Hours

Learning Unit	Learning Outcomes	Learning Elements	Materials Required
LU1:Prepare Workstation for Fleshing	<p>The trainee will be able to:</p> <ul style="list-style-type: none"> Remove hazardous material from work area Analyse job card from supervisor Select correct position in order to minimize fatigue Set Fleshing machine as per requirement 	<ul style="list-style-type: none"> Define PPE State importance of PPE at workstation Enlist the hazardous materials Define the risks involved in case hazardous materials are not removed. Define job card Define how fatigue may affect performance. State importance of correct position to minimize fatigue. Introduction to fleshing machine. <ul style="list-style-type: none"> ○ Introduction to gauge and its setting ○ Introduction to knives ○ Introduction to pressure paddle Introduction to fleshing tools 	<ul style="list-style-type: none"> Computer Multimedia Safety helmet & glasses Safety Gloves Safety Shoes Earplugs Safety Uniform Fleshing Machine Fleshing Machine Operator Manual Knives
LU2:Perform Fleshing	<p>The trainee will be able to:</p> <ul style="list-style-type: none"> Place hide/skin into Fleshing machine from flesh side Operate Fleshing machine 	<ul style="list-style-type: none"> Introduction to fleshing Purpose of fleshing Define fleshing process 	<ul style="list-style-type: none"> Computer Multimedia Fleshing Machine Fleshing Machine Operator Manual

	<p>as per requirement</p> <p>Ensure proper removal of Flesh</p> <p>Segregate damaged hides/skin</p> <p>Pile Fleshed hides/skin</p>	<p>Explain green fleshing</p> <p>Types of fleshing</p> <ul style="list-style-type: none"> ○ hand fleshing ○ machine fleshing <p>Introduction to grain side and flesh of hide/skin</p> <p>Introduction to machine operating manual</p> <p>Explain skin/hide feeding procedure for fleshing machine</p> <p>Define knife fleshing/trimming</p> <p>Importance of knife fleshing/trimming</p> <p>Define damages during fleshing</p>	<p>Hide</p> <p>Skin</p> <p>Knives</p> <p>Pile Horse</p> <p>Steel Table</p>
LU3:Clean Work Place	<p>The trainee will be able to:</p> <p>Remove waste from work place as per instruction</p> <p>Clean machine & tools as per instruction</p> <p>Ensure housekeeping of workplace</p>	<p>Introduction to washing and cleaning of;</p> <ul style="list-style-type: none"> ○ fleshing machine ○ tools & equipment ○ workstation 	<p>Computer</p> <p>Multimedia</p> <p>Fleshing Machine</p> <p>Fleshing Machine Operator Manual</p> <p>Wipers</p> <p>Dust Bins</p>
LU4:Maintain Fleshing Machine Register	<p>The trainee will be able to:</p> <p>Record Fleshing operation entries in register</p> <p>Record damages during Fleshing operation</p>	<p>Introduction to machine register</p> <p>Procedure of recording entries in register</p> <p>Importance of machine register</p>	<p>Computer</p> <p>Multimedia</p> <p>Record Registers</p>

LU1 PREPARE WORKSTATION FOR FLESHING

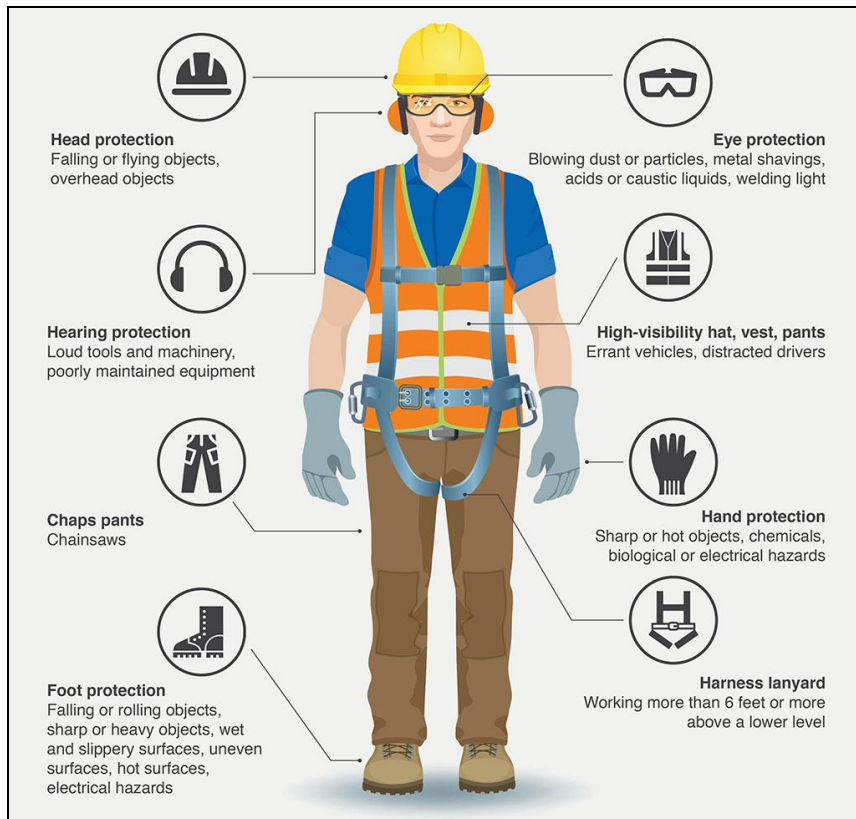

PPE (Personal Protective Equipment):

Personal Protective Equipment (PPE) is clothing or equipment designed to protect workers from physical hazards when on a worksite. PPE should only be considered as a last line of defence between a hazard and the worker. Attempts to control workplace risks and hazards should always be addressed first.

Examples and illustrations

State importance of PPE at workstation:

Workplace safety should begin with a hazard assessment. Once the hazards and risks have been identified, a plan can be put forward to prioritize and reduce risk of injury. Useful systems and tools to perform hazard assessments include performing a Risk Assessment and a Job Safety Analysis.

Basic Types of PPE

Following are the basic types of PPE during Fleshing Operations:

Head Protection: PPE includes hard hats and headgears and should be required for tasks that can cause any force or object falling to the head.

Face and Eye Protection: PPE includes safety goggles and face shields and should be used for tasks that can cause loss of vision and an eye, burns, splashes, sprays of toxic liquids etc

Foot Protection: PPE includes knee pads and safety boots and should be used for tasks that can cause serious foot and leg injuries from falling or rolling objects, hot substances, electrical hazards and slippery surfaces.

Hands Protection: PPE includes safety gloves and should be used

	<p>for tasks that can cause hand and skin burns, absorption of harmful substances, cuts, fractures or amputations.</p> <p>Body Protection: PPE includes safety vests and suits and should be used for tasks that can cause body injuries from extreme temperatures, flames and sparks, toxic chemicals, insect bites and radiation.</p> <p>Fall Protection: PPE includes safety harnesses and lanyards and should be strictly used for task that can cause falling from heights and serious injury or death</p> <p>Respiratory Protection: PPE includes respirators and should be used for task that can cause inhalation of harmful materials to enter the body</p>
--	--

Some hazardous materials of fleshing process

1. Free Lime and Sodium Sulphide Liquids which causes skins burn or damaged particularly in eyes if in contact it should be washed.
2. Loose Flesh of leather which cause slippery surface.
3. Any tools of fleshing machine which is not place in proper place.

The risks involved in case hazardous materials are not removed.

It causes serious life threats specially when come in contact with fleshing machine or continuously skin contact with lime or sodium Sulphide liquid which causes great damage to not only for operator but also for pelts.

Job card

This is a type of document for further job work of fleshing machine.

For more detailed information, please visit: Link <http://results-staffing.com/index.php/importance-personal-protective-equipment/>

Also visit <http://www.hse.gov.uk/toolbox/ppe.htm>

And <https://www.baselinetraining.com/importance-ppe-workplace/>
<https://erpnext.com/docs/user/manual/en/manufacturing/job-card>

LU2 Perform Fleshing

Importance of fatigue during Fleshing Operations:

Any type of fatigue may affect fleshing operations, if pelt pads are not properly placed means it should be from right side to left side to machine or machine is not properly washed and operator is not well trained it causes serious threats.

Fleshing machine:

Leather Fleshing Machine is mainly used for remove flesh and fats from pelts which loses after liming process. It also used for reducing thickness and remove extra fats and flesh from skin.

Following is the diagram for fleshing Machine:



Introduction to knives/Blades:

Leather Fleshing Blades are primarily used in tanneries for processing of raw hides. These blades although look alike its counter parts, Leather Shaving Blades, differ in functionality and specification.

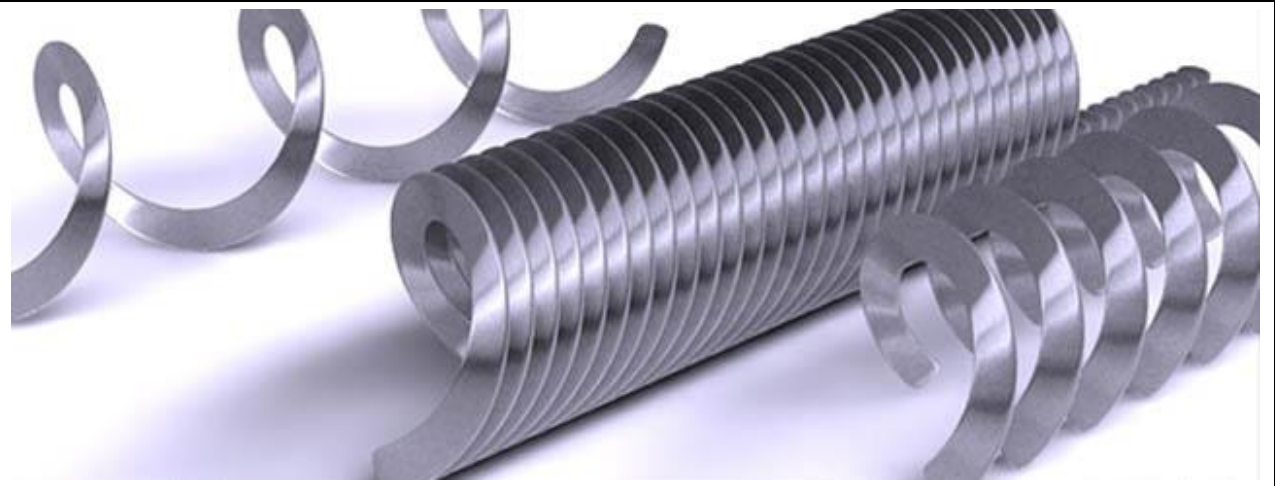

Fleshing Tools:

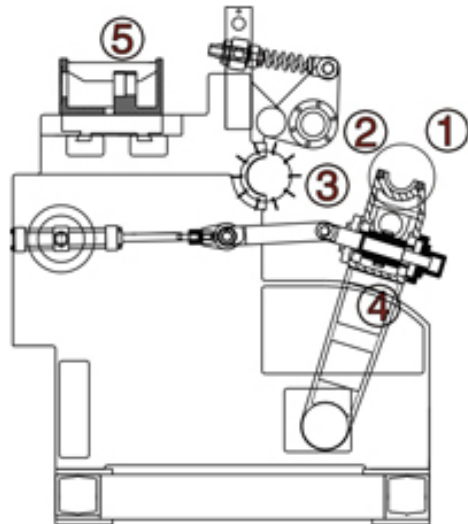

- 1、 Rubber Roller
- 2、 Press Roller
- 3、 Knife Roller
- 4、 Swing Arm
- 5、 Sliding Ways

Pressure paddle

This is Paddle use for moving cylinders for completing fleshing process which is operated but pump motor.

Fleshing

After liming the pelt is passed through a machine to remove fleshy tissue from the flesh side. Hides may be split into layers at this stage or after tanning.

Purpose of Fleshing:

A hide or skin is usually do fleshed for making up an animal skin/hide for further processing. When fleshing of skins/ hides, connective tissue and meat residue are removed from the flesh side of the skin. In the past, special tools were used by the tanner.

Fleshing Process:

Fleshing is usually carried out in fleshing machine in which leather is feed using feeding conveyor and fleshed the skins/hides, sometimes by adjusting gauge of the machine but occasionally leather is also fleshed by hand by placing leather on a slope and removed the flesh from upward to downward.

Green Fleshing:

In leather Processing Fleshing id carried out after liming but sometimes it needs Green fleshing. As the name shows the fleshing of hide/skins before any chemical process is called as green fleshing.

Methods of fleshing

Flowing are the two methods of fleshing:

- hand fleshing
- machine fleshing

Hand Fleshing:

Fleshing carried out by hand in stone slope is called Hand fleshing.



Machine Fleshing:

Fleshing that is carried out using Fleshing Machine

Grain side and flesh of hide/skin:

The Hairs side of the skin or Hide is called Grain side of skin or hide and the lower portion which is flesh side of skins/hide is Fleshed side of Skins/Hide

Machine operating manual:

The Manual of Operating the fleshing machine which is differ from machine to machine

Knife fleshing/trimming:

Trimming is called the extra skin portion of the skin/hide by either knife or scissor. And fleshing is the removal of fats and flesh from the skin and hide.

It is Important to do Fleshing or trimming of skin/hide for makingup the leather for further process if fleshing is not done then extra fats and tissues blocks the further penetrations of chemicals.

Damages during fleshing:

Damages which is caused by fleshing machine is usually cut marks due to irregular fleshing causes lower the quality of leather and often skin/hide is cut in half is not proper feeding of leather into the machine. And if not proper fleshing is carrying out it causes serious life threats.

LU3 CLEAN WORKPLACE**Washing and cleaning of fleshing machine, tools & equipment, workstation:**

After Completing of Fleshing the machines tools and the area around the fleshing should be properly washout and clean.

LU4

Entries of mechanical records:

After Completion of every process their records should be maintained in registered for further enquires and processes.

The Record Entries should normally be carried out by writing number of skins/hides is processed and number of damaged skins/hides if any occurs should be maintained. who has done the process and how much time has spent for completion of process.

For more detailed information, please visit:

Link <https://www.merriam->

HUSSAIN LEATHER CRAFT									
FLESHING PROCESS REGISTER									
FOR THE MONTH OF _____, YEAR OF _____									
Sr. No.	LOT #	PLAN #	RECEIVE DATE	PROCESS COMPLETE DATE	TYPE OF LEAHTER	FLESHED PCS	DAMAGE PCS	TOTAL PCS	REMARKS
1									
2									
3									
4									
5									
6									
7									
8									
9									
10									
11									
12									
13									
14									
15									
16									
17									



Page | 11

Operator Sign _____	Supervisor Sign _____
---------------------	-----------------------

webster.com/dictionary/fleshing%20machine

Video link of fleshing machine operation: https://youtu.be/i_vBp-CFfuE

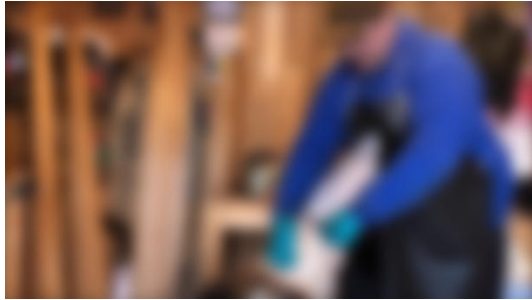
VIDEOS:

	Video Link
	Prepare Workstation for Fleshing https://www.youtube.com/watch?v=nEcJVruXj-s https://www.youtube.com/watch?v=l_8sCpehcxg https://www.youtube.com/watch?v=4uDP4wyADs8
	Perform Fleshing https://www.youtube.com/watch?v=CkTvfes-s0Y https://www.youtube.com/watch?v=T6JZcN3dGVg https://www.youtube.com/watch?v=p4BgaRd3VmA https://www.youtube.com/watch?v=VQTNOYD81fM
	Clean Work Place https://www.youtube.com/watch?v=BOxy2nPebz0 https://www.youtube.com/watch?v=mOUvhsTJcRk https://www.youtube.com/watch?v=YK5cLmcrNcU

LEATHER PROCESSING TECHNOLOGIST



© TVET SSP

Module-6
LEARNER GUIDE
National Vocational Certificate Level 2

Version 1 - September, 2019

Module 6: Carryout Scudding

Objective of the module: The aim of this module to develop advanced knowledge, skills and understanding to carryout Scudding

Duration: 40 Hours **Theory:** 8 Hours **Practical:** 32 Hours

Learning Unit	Learning Outcomes	Learning Elements	Materials Required
LU1: Prepare Workstation for Scudding	<p>The trainee will be able to:</p> <p>Remove hazardous material from work area</p> <p>Analyze Job card from supervisor</p> <p>Place correct tools as per requirement</p> <p>Set Scudding area as per requirement</p>	<p>Define PPE</p> <p>State importance of PPE at workstation</p> <p>Enlist the hazardous materials</p> <p>Define the risks involved in case hazardous materials are not removed.</p> <p>Define job card</p> <p>Introduction to scudding tools</p> <ul style="list-style-type: none"> ○ Scudding knives ○ Sliding beam <p>Selection of scudding knife</p> <p>Importance of setting scudding area</p>	<p>Computer</p> <p>Multimedia</p> <p>Safety helmet & glasses</p> <p>Safety Gloves</p> <p>Safety Shoes</p> <p>Earplugs</p> <p>Safety Uniform</p> <p>Scudding Beam</p> <p>Curved Knives</p>
LU2: Perform Scudding	<p>The trainee will be able to:</p> <p>Set pelt for Scudding</p> <p>Select correct curved knife for Scudding</p> <p>Execute Scudding on PELT</p> <p>Pile Scudded PELT</p>	<p>Define scudding</p> <p>Purpose of scudding</p> <p>Types of scudding</p> <p>Introduction to grain side and flesh of hide/skin</p> <p>Define scudding process & procedure</p> <ul style="list-style-type: none"> ● Method of placing skin on scudding beam 	<p>Computer</p> <p>Multimedia</p> <p>Scudding Beam</p> <p>Curved Knives</p> <p>Hide</p> <p>Skin</p> <p>Pit</p>

		<ul style="list-style-type: none"> • Method of using scudding knife • Define damages during scudding 	Pallet Tub Steel Table
LU3:Clean Work Place	The trainee will be able to: Dispose waste from workplace as per instructions Clean tools as per instruction Ensure housekeeping of workplace	Introduction to washing and cleaning of; <ul style="list-style-type: none"> • scudding knives & equipment • scudding table • workstation 	Computer Multimedia Scudding Beam Curved Knives Steel Table Wiper Dust Bin
LU4:Maintain Scudding Machine Register	The trainee will be able to: Record Scudding operation entries in register Record damages during Scudding operation	Introduction to machine register Define procedure of recording entries in register Importance of register	Computer Multimedia Record Registers

For PPE (Personal Protective Equipment details please visit Module 2 Carryout Fleshing

LU2

Scudding tools:

There is not much scudding tools is required for scudding but only two following:

Scudding knives

It is the blunted knives which are used removing the extraneous material from leather surface Figure Illustrate this.



Sliding beam

It is the beam at which the leather is placed for removing extraneous Material.

Selection of scudding knife:

Scudding Knife is different from fleshing Knives as it is blunted but fleshing knives are sharp.

Setting of scudding area:

The scudding area should be clean extra fat and flesh remain should be washed and clean and washed scudding slide should be used.

Scudding:

After Bating, loosen and cause the peptisation of the structure of the collagen. hydrolysis of interfibrillar proteins, breakdown of the elastin, reticulin, collagen ,fats and loose hair roots. Which comes on surface of skins which is removed by blunt knives this process is called as Scudding.

A hide or skin is usually do Scud for making up an animal skin/hide for further processing. When extra proteins and materials is removed from skins/ hides, the pores of the pelts are open up.



Scudding process & procedure:

Scudding is usually carried out in Scudding slides in which leather is placed from upward to downward by the help of scudding knives which are the special type of knives which normally not cut the skins but clean the surface.

Grain side and flesh of hide/skin:

The Hairs side of the skin or Hide is called Grain side of skin or hide and the lower portion which is flesh side of skins/hide is Fleshed side of Skins/Hide

Damages during Scudding:

Damages which is caused by scudding is usually grain damage due to irregular scudding causes lower the quality of leather.

LU3**Washing and cleaning of scudding machine, tools & equipment, workstation:**

After Completing of Scudding the tools and the area around the scudding should be properly washout and clean.

LU4**Entries of Mechanical Records:**

After Completion of Scudding process their records should be maintained in registered for further enquires and processes.

The Record Entries should normally be carried out by writing number of skins/hides is processed and number of damaged skins/hides if any occurs should be maintained. who has done the process and how much time has spent for completion of process

For
please
more
visit:

<p align="center">HUSSAIN LEATHER CRAFT SCUDDING PROCESS REGISTER FOR THE MONTH OF _____, YEAR OF _____</p>									
Sr. No.	LOT #	PLAN #	RECEIVE DATE	PROCESS COMPLETE DATE	TYPE OF LEAHTER	SCUD PCS	DAMAGE PCS	TOTAL PCS	REMARKS
1									
2									
3									
4									
5									
6									
7									
8									
9									
10									
11									
12									
13									
14									
15									
16									
17									
Operator Sign _____					Supervisor Sign _____				

detailed
information,
Link:



https://www.wrexham.gov.uk/english/heritage/leather_and_wrexham/scudding.htm

Also Visit: <https://steven-edholm.squarespace.com/blog?category=tanning>

And: https://www.youtube.com/watch?v=DyN_xX8NEIk

<https://www.worthpoint.com/worthopedia/antique-1790-tanners-28-two-edged-fleshing>

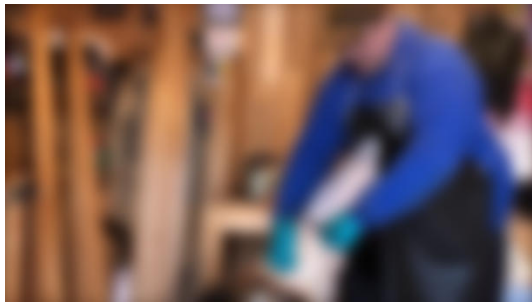
VIDEOS:

	Video Link
	Prepare Workstation for Scudding https://www.youtube.com/watch?v=nEcJVruXj-s https://www.youtube.com/watch?v=l_8sCpehcxg https://www.youtube.com/watch?v=4uDP4wyADs8
	Perform Scudding https://www.youtube.com/watch?v=CkTvfен-s0Y https://www.youtube.com/watch?v=T6JZcN3dGVg https://www.youtube.com/watch?v=p4BgaRd3VmA https://www.youtube.com/watch?v=VQTNOYD81fM

LEATHER PROCESSING TECHNOLOGIST



© TVET SSP

Module-7
LEARNER GUIDE
National Vocational Certificate Level 2

Version 1 - September, 2019

Module 7: Carryout Splitting

Objective of the module: The aim of this module to develop advanced knowledge, skills and understanding to carryout splitting

Duration: 40 Hours **Theory:** 8 Hours **Practical:** 32 Hours

Learning Unit	Learning Outcomes	Learning Elements	Materials Required
LU1: Prepare Workstation for Splitting	<p>The trainee will be able to:</p> <p>Remove hazardous from work area</p> <p>Analyze Job card from supervisor</p> <p>Set Splitting machine as per requirement</p>	<p>Define PPE</p> <p>State importance of PPE at workstation</p> <p>Enlist the hazardous materials</p> <p>Define the risks involved in case hazardous materials are not removed.</p> <p>Define job card</p> <p>Introduction to splitting machine.</p> <ul style="list-style-type: none"> ○ Introduction to gauge and its setting ○ Introduction to knives ○ Introduction to pressure paddle 	<p>Computer</p> <p>Multimedia</p> <p>Safety helmet & glasses</p> <p>Safety Gloves (Welding)</p> <p>Safety Shoes</p> <p>Earplugs</p> <p>Safety Uniform</p> <p>Splitting Machine</p> <p>Splitting Machine Operator Manual</p> <p>Knives</p>
LU2: Perform splitting	<p>The trainee will be able to:</p> <p>Feed tanned leather into splitting machine</p> <p>Operate Splitting machine as per requirement</p> <p>Maintain accuracy of Splitting</p> <p>Segregate damaged hides/skin</p> <p>Pile leather after splitting g machine as per requirement</p>	<p>Define splitting</p> <p>Purpose of splitting</p> <p>Types of splitting</p> <p>Introduction to splitting process</p> <p>Procedure of splitting</p> <p>Define damages during splitting</p>	<p>Computer</p> <p>Multimedia</p> <p>Splitting Machine</p> <p>Splitting Machine Operator Manual</p> <p>Hide</p> <p>Skin</p> <p>Knives</p> <p>Pile Horse</p> <p>Thickness Gauge Meter</p>

LU3:Clean Work Place	The trainee will be able to: Remove waste from work place as per instruction Clean machine & tools as per instruction Ensure housekeeping of workplace	Introduction to cleaning of; <ul style="list-style-type: none">○ splitting machine○ equipment○ workstation	Computer Multimedia Splitting Machine Splitting Machine Operator Manual Air Blower
LU4:Maintain Splitting Register	The trainee will be able to: Record Splitting operation entries in register Record damages during Splitting operation	Introduction to machine register Define procedure of recording entries in register Importance of register	Computer Multimedia Record Registers

LU1

For PPE (Personal Protective Equipment details please visit Module 2 Carryout Fleshing

LU2

Splitting machine:

Leather Splitting Machine is mainly used for split the leather into two parts one is upper portion and other is lower portion from Lime pelts/ Tanned Leather. It also used for reducing thickness.

Following is the diagram for Splitting Machine:



Knives/Blades:

Leather Splitting Blades are primarily used in tanneries for Splitting of hides/Skins. These blades are highly sharp care should be taken for contact with operator body to the machine



ressure paddle

This is Paddle use for moving cylinders for completing Splitting process which is operated but pump motor.

Splitting process

After liming or Tanning the pelt/leather particularly heavy leather like cow/buffalo is usually passed through a machine to split the leather with upper grain surface and flesh side, for adjusting leather thickness according to the desire article.

A hide or skin is usually do Split for making up an animal skin/hide for further processing. When Splitting of hides, the leather is split into two sides the upper grain portion and flesh portion. In the past, special tools were used by the tanner.

Splitting is usually carried out in Splitting machine in which leather is feed using feeding conveyer by adjusting gauge of leather by gauge meter.

Types of Splitting

Flowing are the two types of Splitting:

- Lime Splitting
- Tanned Splitting

Lime Splitting:

Lime Splitting is carried out after liming operation by Splitting Machine.

Tanned Splitting:

Tanned Splitting that is carried out using Splitting Machine after tanning operation.

Damages during Splitting:

There are various Damages which caused by Splitting operations like, if leather is not feed proper into the machine is usually cut/ torn into two pieces which caused damaged of hides .Irregular Splitting causes lower the quality of leather and.

And if not proper Splitting is carrying out it causes serious life threats of operators.

LU3

Washing and cleaning of Splitting machine, tools & equipment, workstation:

After Completing of Splitting the machines tools and the area around the Splitting should be properly washout and clean.

LU4

Entries of mechanical Records:

After Completion of every process their records should be maintained in registered for further enquires and processes.

The Record Entries should normally be carried out by writing number of Split hides is operated and number of damaged hides if any occurs should be maintained. Who has done the process and how much time has spent for completion of process.

link of
Machine:

<p align="center"><u>HUSSAIN LEATHER CRAFT</u> SPLITTING PROCESS REGISTER FOR THE MONTH OF _____, YEAR OF _____</p>									
Sr. No.	LOT #	PLAN #	RECEIVE DATE	PROCESS COMPLETE DATE	GRAIN LEATHER PCS	SPLIT LEATHER PCS	DAMAGE PCS	TOTAL PCS	REMARKS
1									
2									
3									
4									
5									
6									
7									
8									
9									
10									
_____ Operator Sign					_____ Supervisor Sign				

Video
Splitting
&

**more
detailed**

information, please visit: Link: https://www.leather-dictionary.com/index.php/Split_leather

Also Visit: https://www.leather-dictionary.com/index.php/Leather_production

VIDEOS:

	Video Link
	<p>Perform splitting</p> <p>https://youtu.be/FbK4csLC1I8</p> <p>https://www.youtube.com/watch?v=4sxnRnNxMA</p> <p>https://www.youtube.com/watch?v=FT_sLxOfins</p> <p>https://www.youtube.com/watch?v=BU6MYEONzJk</p>

LEATHER PROCESSING TECHNOLOGIST



© TVET SSP

Module-8
LEARNER GUIDE
National Vocational Certificate Level 2

Version 1 - September, 2019

Module 8: Carryout Shaving

Objective of the module: The aim of this module to develop advanced knowledge, skills and understanding to carryout shaving

Duration: 40 Hours **Theory:** 8 Hours **Practical:** 32 Hours

Learning Unit	Learning Outcomes	Learning Elements	Materials Required
LU1: Prepare Workstation for Shaving	<p>The trainee will be able to:</p> <p>Remove hazardous material from work area</p> <p>Analyze Job card from supervisor</p> <p>Set Shaving machine as per requirement</p>	<p>Define PPE</p> <p>State importance of PPE at workstation</p> <p>Enlist the hazardous materials</p> <p>Define the risks involved in case hazardous materials are not removed.</p> <p>Define job card</p> <p>Introduction to gauge meter</p> <p>Introduction to shaving machine.</p> <ul style="list-style-type: none"> ○ Introduction to gauge and its setting ○ Introduction to knives ○ Introduction to pressure paddle ○ Introduction to shaving tools 	<p>Computer</p> <p>Multimedia</p> <p>Safety helmet & glasses</p> <p>Safety Gloves (Welding)</p> <p>Safety Shoes</p> <p>Earplugs</p> <p>Safety Uniform</p> <p>Shaving Machine</p> <p>Shaving Machine Operator Manual</p> <p>Knives/Blades</p> <p>Tool Kits</p>
LU2: Perform Shaving	<p>The trainee will be able to:</p> <p>Feed tanned leather into shaving machine</p> <p>Operate Shaving machine as per requirement</p> <p>Measure thickness of Leather as per requirement</p>	<p>Define shaving</p> <p>Purpose of shaving</p> <p>Types of shaving</p> <p>Introduction to shaving process</p> <p>Procedure of shaving</p> <p>Define damages during shaving</p>	<p>Computer</p> <p>Multimedia</p> <p>Shaving Machine</p> <p>Shaving Machine Operator Manual</p> <p>Hide</p> <p>Skin</p> <p>Knives/Blades</p> <p>Tools Kits</p>

	Segregate damaged hides/skin Pile Shaved leather	Reasons of damages during shaving Define Precautions during shaving	Air Blower Thickness Gauge Meter
LU3:Clean Work Place	The trainee will be able to: Remove waste from work place as per instruction Clean machine & tools as per instruction Ensure housekeeping of workplace	Introduction to cleaning of; <ul style="list-style-type: none"> ○ Shaving machine ○ equipment ○ workstation 	Computer Multimedia Shaving Machine Shaving Machine Operator Manual Air Blower
LU4:Maintain Shaving Machine Register	The trainee will be able to: Record Shaving operation entries in register Record damages during Shaving operation	Introduction to machine register Define procedure of recording entries in register Importance of register	Computer Multimedia Record Registers

LU1

For PPE (Personal Protective Equipment details please visit [Module 2 Carryout Fleshing](#))

LU2

Gauge meter:

Gauge meter is used for checking thickness of leather after subsequent splitting and shaving operations



Shaving machine:

Leather Shaving Machine is mainly used for Shaved the leather for reducing thickness or according to Required Articles.

Following is the diagram for Shaving Machines:

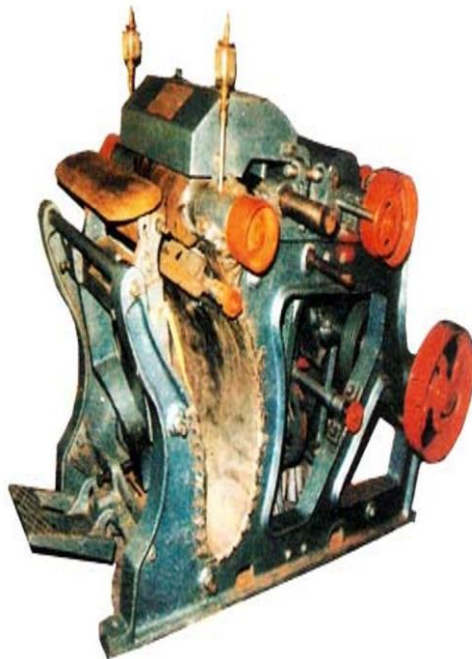

Manual Shaving Machine 1

Automatic Shaving Machine 1

Knives/Blades:

Leather Shaving Blades are primarily used in tanneries for Shaving of hides/Skins. These blades are highly sharp care should be taken for contact with operator body to the machine



Pressure paddle

This is Paddle use for moving cylinders for completing Shaving process which is operated but pump motor.

Shaving tools:

Shaving tools includes shaver blades
Screw for adjusting blades
Motor pump for paddle moving

Shaving:

After Tanning ac sometimes pickling it is required to reduce thickness of leather not only for the end customer demand but also prepare the leather for further processing.

A hide or skin is usually do Shave for making up an animal skin/hide for further processing. When Shaving of hides, the leather is reduced its thickness and produce fine, flesh side, the main objective is the prepare leather for further Processing.

Types of Shaving

Flowing are the two types of Shaving:

- Dry Shaving
- Wet Shaving

Dry Shaving:

Dry Shaving is carried out by manual Shaving Machine or automatic shaving after crust/dyed or dried condition.

Wet Shaving:

Wet Shaving is carried out using manual Shaving Machine or automatic shaving machine usually after tanning operation in wet condition.

Procedure of Shaving:

Shaving is usually carried out in Shaving machine in which leather is feed using feeding conveyor and adjust gauge of leather by gauge meter.

Damages during Shaving:

There are various Damages which caused by Shaving operations like, if leather is not feed proper into the machine is usually cut/ torn into two pieces which caused damaged of leather and produce low quality Leather. Irregular Shaving causes lower the quality of leather and. And if not proper Shaving is carrying out it causes serious life threats of operators.

Reasons of Damages during shaving:

- Improper Feeding.
- Shaver Blades or other Tools is not proper fitted.
- Inadequate use by operator.
- Unskilled worker.

Precautions during shaving:

- Operator should be proper Skill and should have working knowledge.
- Machine should be fitted properly.
- Leather should be proper feed into the Machine.

LU3

Washing and cleaning of Shaving machine, tools & equipment, workstation:

After Completing of Shaving the machines and its tools and the area around the Shaving should be properly washout and clean.

LU4

Entries of mechanical records:

After Completion of every process their records should be maintained in registered for further enquires and processes.

The Record Entries should normally be carried out by writing number of Shaved hides is operated and number of damaged hides if any occurs should be maintained. Who has operated the process and how much time has spent for completion of process.

For more information,
Link:

detailed
please visit:

<u>HUSSAIN LEATHER CRAFT</u> SHAVING PROCESS REGISTER FOR THE MONTH OF _____, YEAR OF _____									
Sr. No.	LOT #	PLAN #	RECEIVE DATE	PROCESS COMPLETE DATE	LEATHER TYPE	SHAVED PCS	DAMAGE PCS	TOTAL PCS	REMARKS
1									
2									
3									
4									
5									
6									
7									
8									
9									
10									
_____ Operator Sign					_____ Supervisor Sign				

<https://www.leather-dictionary.com/index.php/Shaving>

Also Visit: <http://www.leatherresource.com/shavingtrimming.html>

VIDEOS:

	Video Link
	<p>Perform Shaving https://youtu.be/CS2hi06EXI0 https://www.youtube.com/watch?v=zW4kXsGN954 https://www.youtube.com/watch?v= NTvjVv5-yI</p>

LEATHER PROCESSING TECHNOLOGIST



© TVET SSP

Module-9
LEARNER GUIDE
National Vocational Certificate Level 2

Version 1 - September, 2019

Module 9: Carryout Sammying - Setting

Objective of the module: The aim of this module to develop advanced knowledge, skills and understanding to carryout sammying – setting

Duration: 40 Hours **Theory:** 8 Hours **Practical:** 32 Hours

Learning Unit	Learning Outcomes	Learning Elements	Materials Required
LU1: Prepare Workstation for Sammying - Setting out	<p>The trainee will be able to:</p> <p>Remove hazardous material from work place</p> <p>Analyze Job card from supervisor</p> <p>Set Sammying - Setting out machine as per requirement</p>	<p>Define PPE</p> <p>State importance of PPE at workstation</p> <p>Enlist the hazardous materials</p> <p>Define the risks involved in case hazardous materials are not removed.</p> <p>Define job card</p> <p>Introduction to sammying-setting out machine.</p> <p>Introduction to gauge and its setting</p> <p>Introduction to blend knives</p> <p>Introduction to pressure paddle</p>	<p>Computer</p> <p>Multimedia</p> <p>Safety helmet & glasses</p> <p>Safety Gloves</p> <p>Safety Shoes</p> <p>Earplugs</p> <p>Safety Uniform</p> <p>Sammying & Setting Machine</p> <p>Sammying & Setting Machine Operator Manual</p> <p>Tools Kits</p>
LU2: Perform Sammying - Setting out	<p>The trainee will be able to:</p> <p>Feed leather into Sammying – Setting out machine</p> <p>Operate Sammying - Setting out machine as per requirement</p>	<p>Define sammying-setting out</p> <p>Purpose of sammying-setting out</p> <p>Introduction to sammying-setting out machine manual</p> <p>Introduction to sammying-setting out process</p> <p>Perform sammying-setting out</p>	<p>Computer</p> <p>Multimedia</p> <p>Sammying - Setting Machine</p> <p>Pile Horse</p> <p>Sammying - Setting Machine Operator Manual</p>

	Pile Leather		Hide Skin
LU3: Clean Work Place	<p>The trainee will be able to:</p> <p>Clean machine as per instruction</p> <p>Ensure housekeeping of workplace</p>	<p>Introduction to cleaning of</p> <ul style="list-style-type: none"> ○ Sammying-setting out machine ○ Workstation 	<p>Computer Multimedia</p> <p>Sammying - Setting Machine</p> <p>Sammying – Setting Machine Operator Manual</p> <p>Air Blower</p>
LU4: Maintain Sammying – Setting out machine register	<p>The trainee will be able to:</p> <p>Record Sammying - Setting out operation entries in register</p> <p>Record damages during Sammying - Setting out</p>	<p>Introduction to machine register</p> <p>Define procedure of recording entries in register</p> <p>Importance of register</p>	<p>Computer Multimedia</p> <p>Record Registers</p>

LU1

For PPE (Personal Protective Equipment details please visit Module 2 Carryout Fleshing

Blunt Knives:

Leather Sammying and Setting Machine is not use for cutting purpose, it just used for increase area and remove excess water so the blades is used blunt for this operation.

Pressure paddle

This is Paddle use for moving cylinders for completing Sammying and Setting process which is operated but pump motor.

Sammying and Setting:

After wet end process leather required for removing excess water for preparing leather for further mechanical process.



A hide or skin is usually do Samm-Sett for making up an animal skin/hide for further processing. When Sammying of leather, the leather is reduced its water content specially loose water from leather and also leather is flat by increasing area of leather.

Sammying and Setting Manual:

Sammying and Setting machine is usually operated by operator after following manuals for reduce damages and injuries.

LU2

Perform Sammying Setting Out:

Sammying and Setting is carried out by feeding leather into machine and handled by paddle with almost 1 to 2 passes leather is taken out from machine

LU3

Washing and cleaning of Shaving machine, tools & equipment, workstation:

After Completing of Sammying and Setting the machines and its tools and the area around the Sammying and Setting should be properly washout and clean.

LU4

Entries of mechanical records:

After Completion of every process their records should be maintained in registered for further enquires and processes.

The Record Entries should normally be carried out by writing number of Sammed hides/Skin is operated and number of damaged hides if any occurs should be maintained. Who has operated the process and how much time has spent for completion of process.

HUSSAIN LEATHER CRAFT
SAMMYING SETTING PROCESS REGISTER
 FOR THE MONTH OF _____, YEAR OF _____

Sr. No.	LOT #	PLAN #	RECEIVE DATE	PROCESS COMPLETE DATE	LEATHER TYPE	SAM-SET PCS	DAMAGE PCS	TOTAL PCS	REMARKS
1									
2									
3									
4									
5									
6									
7									
8									
9									
10									

 Operator Sign

 Supervisor Sign

For more detailed information, please visit: Link: https://en.wikipedia.org/wiki/Leather_production_processes

Also Visit: <http://www.dollfus-muller.com/en/sammying-machine/>

VIDEOS:

	Video Link
	<p>Perform Sammying – Setting out https://youtu.be/c2M79OObX0</p>

LEATHER PROCESSING TECHNOLOGIST



© TVET SSP

Module-10

LEARNER GUIDE

National Vocational Certificate Level 2

Version 1 - September, 2019

Module 10: Carryout Drying

Objective of the module: The aim of this module to develop advanced knowledge, skills and understanding to carryout drying

Duration: 40 Hours **Theory:** 8 Hours **Practical:** 32 Hours

Learning Unit	Learning Outcomes	Learning Elements	Materials Required
LU1: Prepare Workstation for Drying	<p>The trainee will be able to: Remove hazardous from work place Analyze Job card from supervisor Select Drying method as per job requirement Set Drying machine as per requirement</p>	<p>Define PPE State importance of PPE at workstation Enlist the hazardous materials Define the risks involved in case hazardous materials are not removed. Define job card Introduction to Drying machine.</p> <ul style="list-style-type: none"> ○ Timer setting ○ Temperature setting ○ Pressure setting 	<p>Computer Multimedia Safety helmet & glasses Safety Gloves (Welding) Safety Shoes Earplugs Safety Uniform Drying Machine Drying Machine Operator Manual Tool Kit Hanging Clips</p>
LU2: Perform Drying	<p>The trainee will be able to: Place leather into drying machine Operate Drying machine as per requirement Hang Leather as per instruction</p>	<p>Define Drying Purpose of Drying Introduction to types of drying Define damages during drying Reasons of damages during drying Introduction to Drying machine manual</p>	<p>Computer Multimedia Drying Machine Drying Machine Operator Manual Hide Skin Tool Kit Scraper (Fiber)</p>

		Introduction to Drying process Perform drying Moisture content checking importance	Pile Horse Hanging Clips
LU3:Clean Work Place	The trainee will be able to: Clean machine as per instruction Ensure housekeeping of workplace	Introduction to cleaning of <ul style="list-style-type: none"> ○ Drying machine ○ Tools & equipment ○ workstation 	Computer Multimedia Drying Machine Drying Machine Operator Manual Air Blower
LU4:Maintain Drying machine register	The trainee will be able to: Record Drying operation entries in register Record damages during Drying operation	Introduction to machine register Define procedure of recording entries in register Importance of register	Computer Multimedia Record Registers

LU1

For PPE (Personal Protective Equipment details please visit Module 2 Carryout Fleshing

Drying Machine/Chamber:

Drying Machines or chambers are mainly used for drying the light leather as well as hard leather, it contain control parameters like:

Time Setting:

Time setting which include setting of seconds by which the leather is placed on machines (i.e. Vacuum Machine).

Temperature Setting:

Some Drying machines like Toggle and vacuum drying and also hanging Chambers temperature can be maintained.

Pressure Setting:

Drying methods like vacuum drying pressure will also be adjusted with Temperature according to the final article demand

LU2

Drying:

In leather processing drying step is came in many steps like after wet end process, dyeing process which is due to perform of mechanical operations like staking, dry shaving.

Light leather like gloving and garments leather often need crust and dyed process separately, due to some mechanical operations like staking, measurements, drying shavings so to carrying out individually Drying Process should be carried out. Same process for other types of leather like upper, garments etc.

Following are some kinds of Drying Methods:

Mechanical Dewatering:

To flush water out of dripping, freshly tanned hides, the hides are pressed between two metal cylinders. It is comparable to wringing out washing before hanging it out to dry.

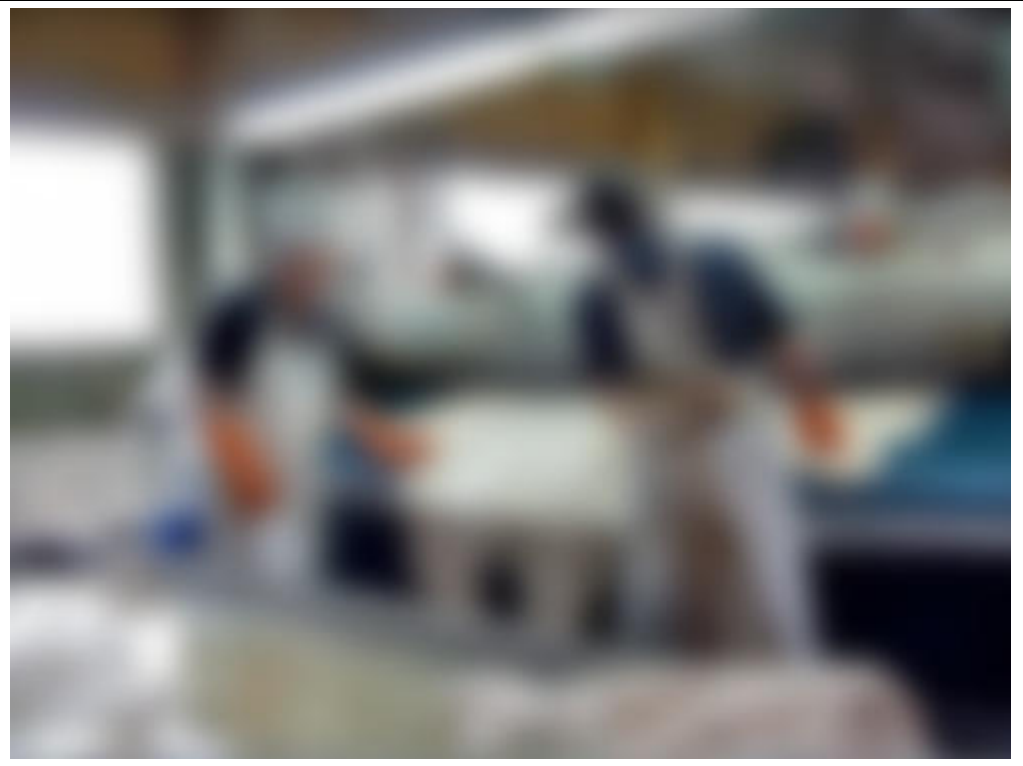



Air Drying or Ground Drying or Frame Drying:

Drying hides by exposing the flesh side to mild rays of the sun is a cheaper method but one that takes substantially longer to dry. The hides can just be put on the floor or they can be tensioned by lacing them into a square wooden frame. Stretched hides maintain more surface and shrink less during the drying process when placed in drying frames



Drying by Hanging:

The leather is dried as smoothly as possible by hanging on hooks or over bars at normal room temperature and increased air movement, if possible. Depending on the type of leather, this can take up to several weeks. It is a suitable method for thin and soft leathers. The deformation of the leather is higher, because it is not hindered.

**Vacuum Drying:**

Vacuum drying is based on the physical principle that water evaporates at low pressure at low temperature. In the vacuum dryers, leather is placed with the grain side on heated polished metal surfaces and then the water vapour is sucked out of the vacuum chamber.

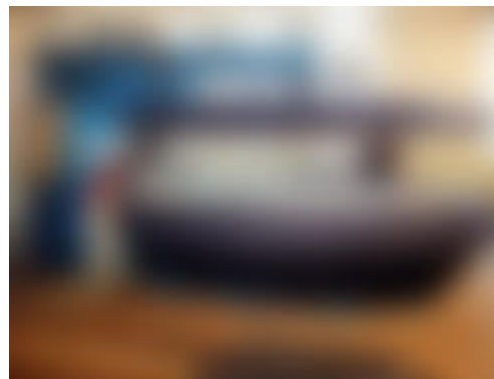

Damages during drying:

There is not very much damages due to drying accept improper handling and feeding or placing leather is oftenly torn out or stains of other machines chemicals like Grease will come.

Reasons for Damages during Drying:

Improper feeding of leather or placing on vacuum machines or other drying machines damages can be occurs some machines like vacuum drying it cause danger to operator also.

Drying Machine Manual:

Drying machine is usually operated by operator after following manuals for reduce damages and injuries.

In drying different methods are used the cheapest method is hang dry after that drying chamber and others include vacuum drying. The methods of placing or feeding in different machines is different like in vacuum drying the leather are placed straight on vacuum machine under certain temperature and pressure, in hang drying leather is simple dried upon hanging in the hooks or placing in open ground similarly in Toggle drying the leather is stretch using clips which not only dry the leather but also stretch the leather area.

Moisture Content:

Moisture Content is checked by the different moisture checker meter that is necessary according to different weather condition.



LU3

Washing and cleaning of Drying machine, tools & equipment, workstation:

After Completing of Drying the machines and its tools and the area around the Drying should be properly washout and clean.

LU4

Entries of mechanical records:

After Completion of every process their records should be maintained in registered for further enquires and processes.

The Record Entries should normally be carried out by writing number of Dried hides/Skin is operated and number of damaged hides if any occurs should be maintained. Who has operated the process and how much time has spent for completion of process.

HUSSAIN LEATHER CRAFT

DRYING SETTING PROCESS REGISTER

FOR THE MONTH OF _____, YEAR OF _____

Sr. No.	LOT #	PLAN #	RECEIVE DATE	PROCESS COMPLETE DATE	LEATHER TYPE	DRIED PCS	DAMAGE PCS	TOTAL PCS	REMARKS
1									
2									
3									
4									
5									
6									
7									
8									
9									
10									

Operator Sign

Supervisor Sign

For more detailed information, please visit: Link: https://www.leather-dictionary.com/index.php/Drying_leather

Also Visit: https://www.leather-dictionary.com/index.php/Preservation_by_drying_salting_or_freezing

VIDEOS:

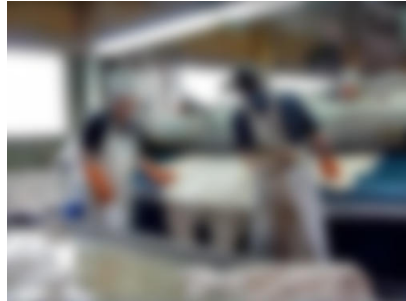
	Video Link
	<p>Perform Drying https://youtu.be/mAN_lyFq2kg https://www.youtube.com/watch?v=Pnidx1ykrqU https://www.youtube.com/watch?v=uiWJLqHKFPE</p>

LEATHER PROCESSING TECHNOLOGIST



© TVET SSP

Module-11

LEARNER GUIDE

National Vocational Certificate Level 2

Version 1 - September, 2019

Module 11: Carryout Staking

Objective of the module: The aim of this module to develop advanced knowledge, skills and understanding to carryout staking

Duration: 40 Hours **Theory:** 8 Hours **Practical:** 32 Hours

Learning Unit	Learning Outcomes	Learning Elements	Materials Required
LU1: Prepare Workstation for Staking	<p>The trainee will be able to:</p> <p>Remove hazardous from work place</p> <p>Analyze Job card from supervisor</p> <p>Select Staking method as per job requirement</p> <p>Set Staking machine as per requirement</p>	<p>Define PPE</p> <p>State importance of PPE at workstation</p> <p>Enlist the hazardous materials</p> <p>Define the risks involved in case hazardous materials are not removed.</p> <p>Define job card</p> <p>Introduction to Staking machine.</p> <p>Wheel Staking Machine</p> <p>Horizontal Staking Machine</p> <p>Vertical Staking Machine</p>	<p>Computer</p> <p>Multimedia</p> <p>Safety helmet & glasses</p> <p>Safety Gloves</p> <p>Safety Shoes</p> <p>Earplugs</p> <p>Safety Uniform</p> <p>Staking Machine</p> <p>Staking Machine Operator Manual</p>
LU2: Perform Staking	<p>The trainee will be able to:</p> <p>Place leather into staking machine</p> <p>Operate Staking machine as per requirement</p> <p>Segregate damaged leather</p> <p>Pile the Leather</p>	<p>Define Staking</p> <p>Purpose of Staking</p> <p>Introduction to types of Staking</p> <p>Define damages during staking</p> <p>Reasons of damages during staking</p> <p>Introduction to Staking machine manual</p> <p>Introduction to Staking process</p>	<p>Computer</p> <p>Multimedia</p> <p>Staking Machine</p> <p>Staking Machine Operator Manual</p> <p>Hide</p> <p>Skin</p> <p>Clips</p> <p>Tool Kit</p> <p>Pile Horse</p>

		Perform Staking	
LU3:Clean Work Place	The trainee will be able to: Dispose waste as per instruction Clean machine as per instruction Ensure housekeeping of workplace	Introduction to cleaning of; <ul style="list-style-type: none"> ○ Staking machine ○ workstation 	Computer Multimedia Staking Machine Staking Machine Operator Manual Air Blower
LU4: Maintain Staking machine register	The trainee will be able to: Record Staking operation entries in register Record damages during Staking operation	Introduction to machine register Define procedure of recording entries in register Importance of register	Computer Multimedia Record Registers

LU1

For PPE (Personal Protective Equipment details please visit Module 2 Carryout Fleshing

LU2

Staking Machine:

It's widely used in all the process in tannery. It can be placed on bench or platform, also it can be combined used by other tannery machines. It can be connected with leather spraying machine, ironing machine, measuring machine, embossing machine, buffing machine, roller coating machine and etc. It saves manpower and levels up the productivity.

Types of staking:

Mainly there are two types of staking is using in leather industry now a days.

Wheel Staking: It is used for garment leather

Horizontal Vibrating Staking: This is normally called Molisa in industry

Wheel Staking Machine:

This type of staking machine is mainly used for garment and soft leather like gloves and also for softy upper type leather.



Reasons for Damages during Drying:

Improper feeding of leather or placing on machines, damages can be occurs to both leather and operator too.

Staking Machine Manual:

Drying machine is usually operated by operator after following manuals for reduce damages and injuries.

Leather is feed into the staking machine carefully avoiding improper use by operator. From one side and get the leather from another side of machine. In case of wheel staking leather is simply put into the staking machine by single operator and continue staking unless leather is soft as per demand of the article

LU3**Cleaning of Staking machine, tools & equipment, workstation:**

After Completing of Staking the machines and its tools and the area around the Staking should be properly clean.

LU4**Entries of mechanical records:**

After Completion of every process their records should be maintained in registered for further enquires and processes.

The Record Entries should normally be carried out by writing number of Staked hides/Skin is operated and number of damaged hides if any occurs should be maintained. Who has operated the process and how much time has spent for completion of process.

VIDEOS:

	Video Link
	<p>Perform Staking</p> <p>https://youtu.be/MHB3Q2qiKdl</p> <p>https://www.youtube.com/watch?v=MHB3Q2qiKdl</p> <p>https://www.youtube.com/watch?v=hYfwYYzNgtQ</p> <p>https://www.youtube.com/watch?v=f9mUY8KM9hA</p>

G

HUSSAIN LEATHER CRAFT

STAKING PROCESS REGISTER

FOR THE MONTH OF _____, YEAR OF _____

Sr. No.	LOT #	PLAN #	RECEIVE DATE	PROCESS COMPLETE DATE	LEATHER TYPE	STAKED PCS	DAMAGE PCS	TOTAL PCS	REMARKS
1									
2									
3									
4									
5									
6									
7									
8									
9									
10									

Operator Sign

Supervisor Sign

LEATHER PROCESSING TECHNOLOGIST



© TVET SSP

Module-12
LEARNER GUIDE
National Vocational Certificate Level 2

Version 1 - September, 2019

Module 12: Carryout Toggling

Objective of the module: The aim of this module to develop advanced knowledge, skills and understanding to carryout toggling

Duration: 40 Hours **Theory:** 8 Hours **Practical:** 32 Hours

Learning Unit	Learning Outcomes	Learning Elements	Materials Required
LU1: Prepare Workstation for Toggling	<p>The trainee will be able to: Remove hazardous material from work place Analyze Job card from supervisor Set Toggle machine as per requirement</p>	<p>Define PPE State importance of PPE at workstation Enlist the hazardous materials Define the risks involved in case hazardous materials are not removed. Define job card Introduction to Toggling machine Importance of controls in toggling machine Explain controls of toggling machine</p>	<p>Computer Multimedia Safety helmet & glasses Safety Gloves Safety Shoes Earplugs Safety Uniform Toggling Machine Toggling Machine Operator Manual Toggling Clips Toggling Chambers</p>
LU2: Perform Toggling	<p>The trainee will be able to: Set leather on Toggle stand Operate Toggling machine Pile Leather as per instruction</p>	<p>Define Toggling Purpose of Toggling Introduction to Toggling machine manual Introduction to Toggling process Perform Toggling Define damages during toggling Reasons of damages during toggling</p>	<p>Computer Multimedia Toggling Machine Toggling Machine Operator Manual Hide Skin Tool Kits Toggling clips/clamps Pile Horse Fan</p>

			Toggle Chamber
LU3: Clean Work Place	The trainee will be able to: Clean machine as per instruction Ensure housekeeping of workplace	Introduction to cleaning of; <ul style="list-style-type: none"> ○ Toggling machine ○ Tools & equipment ○ workstation 	Computer Multimedia Toggling Machine Toggling Machine Operator Manual
LU4: Maintain Toggling machine register	The trainee will be able to: Record Toggling operation entries in register Record damages during Toggling operation	Introduction to machine register Define procedure of recording entries in register Importance of register	Computer Multimedia Record Registers

LU1

For PPE (Personal Protective Equipment details please visit [Module 2 Carryout Fleshing](#))

LU2

Introduction to Toggling machine:

Toggle drying is a time-tested leather drying method employed at most tanneries. Whether drying raw hides or dyed leathers, with homemade frames against a barn wall or million-dollar automated monster machines with PLC controlled, multi-zoned drying environment. There is one thing every dryer has in common: Securing the skin to the frame with toggle clips.

While toggle operators may seem to have a simple job, they account for the most days lost to injury in automotive leather production. It's surprising until you look at the simplest part of the machine: Toggle clips.

Following is the diagram for Toggling Machine:

There are three main controls of toggle Temperature, Timing and Pressure these all controls are measured and manage according to the article of leather.



Temperature: it is manage according to the climate and type of article that will be created.

Pressure: It is adjusted manually according to the desire article

Time: Timing is the big factor for toggling means for hard types of articles more time is require and for soft article of leather less time is require.

There are many processes that determine how a particular tannage will behave once the leather is finished into product. One of these processes is how the leather is dried. Toggled hides are allowed to air dry, but they are stretched gently through the use of small clamps called toggles. It allows the leather to shrink and plump some, but holds it firm to reduce stretch ability. I have to admit, my motivation for this post was the fact that the toggling room is my favorite room in the building.

In order to stretch the leather and increase surface area with proper drying we do toggling.

Toggling Process:

Toggling is usually carried out in Toggling drying machine in which leather is stretched in machine frames by the help of toggle clips and allow it to pre adjusted time after that remove it from machine after certain time.

Toggle drying machine is usually operated by operator after following manuals for reduce damages and injuries.

Damages during toggling:Leather can be torn out if proper stretch of leather is not done and if improper handling of leather and machine can cause damages to operators and leather.

Reasons of Damages of toggling:

Mostly leather is damaged after toggling due to improper handling and improper stretching of leather on toggle frames and sometimes it also damage the operator which contact with it.

LU3

Cleaning of Toggling machine, tools & equipment, workstation:

After Completing of Toggling the machines tools and the area around the Toggling should be properly clean.

LU4

Entries of mechanical records:

After Completion of every process their records should be maintained in registered for further enquires and processes. The Record Entries should normally be carried out by writing number of Staked hides/Skin is operated and number of damaged hides if any occurs should be maintained. Who has operated the process and how much time has spent for completion of process.

HUSSAIN LEATHER CRAFT

TOGGLING PROCESS REGISTER

FOR THE MONTH OF _____, YEAR OF _____

Sr. No.	LOT #	PLAN #	RECEIVE DATE	PROCESS COMPLETE DATE	LEATHER TYPE	TOGGLE PCS	DAMAGE PCS	TOTAL PCS	REMARKS
1									
2									
3									
4									
5									
6									
7									
8									
9									
10									

Operator Sign

Supervisor Sign

For more detailed information, please visit: Link: <https://www.horween.com/blog/2010/08/06/technique-toggling-and-drying>

Also Visit: <http://agris.fao.org/agris-search/search.do?recordID=US201301956813>

VIDEOS:

	Video Link
	<p>Perform Toggling</p> <p>https://youtu.be/rjDcPJWe95I</p> <p>https://www.youtube.com/watch?v=rUDiSd_V0P4</p> <p>https://www.youtube.com/watch?v=iJ2TFYG4Vv4</p> <p>https://www.youtube.com/watch?v=EfC3nAhq_AM</p>

LEATHER PROCESSING TECHNOLOGIST



© TVET SSP

Module-13

LEARNER GUIDE

National Vocational Certificate Level 2

Version 1 - September, 2019

Module 13: Carryout Buffing

Objective of the module: The aim of this module to develop advanced knowledge, skills and understanding to carryout buffing.

Duration: 40 Hours **Theory:** 8 Hours **Practical:** 32 Hours

Learning Unit	Learning Outcomes	Learning Elements	Materials Required
LU1: Prepare Workstation for Buffing	<p>The trainee will be able to: Remove hazardous material from workplace Analyze Job card from supervisor Select Buffing paper as per job requirement Set Buffing machine as per requirement</p>	<p>Define PPE State importance of PPE at workstation Enlist the hazardous materials Define the risks involved in case hazardous materials are not removed. Define job card Introduction to Buffing machine. Introduction to Buffing paper and its types Uses of buffing paper</p>	<p>Computer Multimedia Safety helmet & glasses Safety Gloves Safety Shoes Earplugs Safety Uniform Buffing Machine Buffing Machine Operator Manual Buff Paper Tool Kits</p>
LU2: Perform Buffing	<p>The trainee will be able to: Feed leather into buffing machine Operate Buffing machine as per requirement Perform de-dusting as per requirement Check Buffing nap of Leather as per requirement</p>	<p>Define Buffing Purpose of Buffing Introduction to Buffing machine manual Introduction to Buffing process Perform buffing Define damages during buffing Reasons of damages during buffing Purpose of de-dusting</p>	<p>Computer Multimedia Buffing Machine Buffing Machine Operator Manual Hide Skin Buff Paper Tool Kits Air Blower</p>

	Pile Buffed leather	Procedure of de-dusting	
LU3:Clean Work Place	The trainee will be able to: Dispose waste as per instruction Clean machine as per instruction Ensure housekeeping of workplace	Introduction to cleaning of; <ul style="list-style-type: none"> ○ Buffing machine ○ workstation 	Computer Multimedia Buffing Machine Buffing Machine Operator Manual Air Blower
LU4: Maintain Buffing machine register	The trainee will be able to: Record Buffing operation entries in register Record damages during Buffing operation	Introduction to machine register Define procedure of recording entries in register Importance of register	Computer Multimedia Record Registers

LU1

For PPE (Personal Protective Equipment details please visit Module 2 Carryout Fleshing

Introduction to Buffing machine:

Buffing machines are suitable for buffing of leather on both the grain and flesh sides. The machines are robust in construction and easy to operate even though they are sensitive and accurate. Details of experience in manufacturing tannery machinery and sound technology backed up by prompt after sales service will guarantee a highly productive machine with superior quality and longer life.

Following is the diagram for Buffing Machine



:

LU3

Introduction to Buff papers and its types:

Buffing papers are the simplest form of sand paper with different numbers which will need according to different types of articles.

Uses of Buffing Papers:

Buffing papers are used for removing the grain portion by rubbing mechanism on the leather surface.

Buffing

Sanding leather – Buffing Leather involves applying an abrasive paper on a rotating roller to the surface (grain side) or reverse (flesh side). This results in a uniform surface. In the earlier times of leather production, such work was purely done manually.

Purpose of Buffing:

In order to make leather velvety look and remove grain for hiding the defects buffing operation is carrying out for making low grade to high grade leather.

Introduction to Buffing machine manual:

Buffing machine is usually operated by operator after following manuals for reduce damages and injuries.

Buffing Process:

Hides are inserted through a machine equipped with an abrasive cylinder which removes the top surface of the leather.

In corrected grain leathers, this operation is carried out to remove the various imperfections (scars, tick bites, brands, etc.) Before a pigmented finish is applied.

In Nubuk and Suede, buffing is done to achieve the classic velvety look.

Damages during Buffing:

Leather with low quality can be torn if proper buffing of leather is not done and if improper handling of leather and machine can cause damages to operators and leather.

Reasons of Damages of Buffing:

Mostly leather is damaged after Buffing due to improper handling and improper stretching of leather on Buffed machine and sometimes it also damage the operator which contact with it.

Purpose of Dedusting:

After completion of buffing leather is covered with buffed dust which should be removed before going to further steps specially before finishing.

Procedure of Dedusting:

Dedusting is carried out with the high blow of air with high pressure air extra buffing dust is remove from leather.

Introduction to cleaning of Buffing machine, tools & equipment, workstation:

After Completing of Buffing the machines tools and the area around the Buffing should be properly clean.

LU4

Entries of mechanical records:

After Completion of every process their records should be maintained in registered for further enquires and processes.

The Record Entries should normally be carried out by writing number of Staked hides/Skin is operated and number of damaged hides if any occurs should be maintained. Who has operated the process and how much time has spent for completion of process.

HUSSAIN LEATHER CRAFT

BUFFING PROCESS REGISTER

FOR THE MONTH OF _____, YEAR OF _____

Sr. No.	LOT #	PLAN #	RECEIVE DATE	PROCESS COMPLETE DATE	LEATHER TYPE	BUFFED PCS	DAMAGE PCS	TOTAL PCS	REMARKS
1									
2									
3									
4									
5									
6									
7									
8									
9									
10									

Operator Sign

Supervisor Sign

For more detailed information, please visit: Link: https://www.leather-dictionary.com/index.php/Sanding_leather

Also Visit: <http://www.all-about-leather.co.uk/what-is-leather/how-is-leather-made.htm>

VIDEOS:

	Video Link
	<p>Perform Buffing</p> <p>https://youtu.be/f9mUY8KM9hA</p> <p>https://www.youtube.com/watch?v=f9mUY8KM9hA</p> <p>https://www.youtube.com/watch?v=xu-fJYFP8YE</p> <p>https://www.youtube.com/watch?v=jtzQeISsqAg</p> <p>https://www.youtube.com/watch?v=LBBapAX3cs8</p>

LEATHER PROCESSING TECHNOLOGIST



© TVET SSP

Module-14

LEARNER GUIDE

National Vocational Certificate Level 2

Version 1 - September, 2019

Module 14: Carryout Hydraulic Press

Objective of the module: The aim of this module to develop advanced knowledge, skills and understanding to carryout Hydraulic Press

Duration: 40 Hours **Theory:** 8 Hours **Practical:** 32 Hours

Learning Unit	Learning Outcomes	Learning Elements	Materials Required
LU1: Prepare Workstation for Hydraulic Press	<p>The trainee will be able to:</p> <p>Remove hazardous material from workplace</p> <p>Analyze Job card from supervisor</p> <p>Select Embossing Plates as per requirement</p> <p>Set Hydraulic Press machine as per requirement</p>	<p>Define PPE</p> <p>State importance of PPE at workstation</p> <p>Enlist the hazardous materials</p> <p>Define the risks involved in case hazardous materials are not removed.</p> <p>Define job card</p> <p>Introduction to Hydraulic Press machine.</p> <p>Introduction to Hydraulic Press Plates</p> <p>Types of hydraulic press plates</p> <p>Importance of controls in hydraulic press machine</p> <p>Explain controls of hydraulic press machine</p>	<p>Computer</p> <p>Multimedia</p> <p>Safety helmet & glasses</p> <p>Safety Gloves</p> <p>Safety Shoes</p> <p>Earplugs</p> <p>Safety Uniform</p> <p>Hydraulic Machine</p> <p>Hydraulic Machine Operator Manual</p> <p>Hydro press plate (Plain)</p> <p>Hydro press plate (hair-cell)</p> <p>Hydro press plate (milled)</p> <p>Tool Kits</p>
LU2: Perform Hydraulic Press	<p>The trainee will be able to:</p> <p>Place Leather into Hydraulic Press</p> <p>Operate Hydraulic Press as per</p>	<p>Define Embossing</p> <p>Purpose of Embossing</p> <p>Introduction to Hydraulic Press machine manual</p>	<p>Computer</p> <p>Multimedia</p> <p>Hydraulic Machine</p> <p>Hydraulic Machine</p>

	<p>requirement</p> <p>Examine Hydraulic Press Effect on leather as per requirement</p> <p>Pile Embossed Leather</p>	<p>Introduction to Embossing process</p> <p>Perform Embossing</p> <p>Define damages during hydraulic press</p> <p>Reasons of damages during hydraulic press</p> <p>Precautions to take during hydraulic press</p>	<p>Operator Manual</p> <p>Hide</p> <p>Skin</p> <p>Hydro press plate (Plain)</p> <p>Hydro press plate (hair-cell)</p> <p>Hydro press plate (milled)</p> <p>Tool Kits</p> <p>Pallet Jacks</p> <p>Large Wooden Scraper</p>
LU3:Clean Work Place	<p>The trainee will be able to:</p> <p>Clean machine as per instruction</p> <p>Ensure housekeeping of workplace</p>	<p>Introduction to cleaning of;</p> <ul style="list-style-type: none"> ○ Hydraulic Press machine ○ workstation 	<p>Computer</p> <p>Multimedia</p> <p>Hydraulic Machine</p> <p>Hydraulic Machine Operator Manual</p> <p>Air Blower</p>
LU4: Maintain Hydraulic Press machine register	<p>The trainee will be able to:</p> <p>Record Hydraulic Press Machine operation entries in register</p> <p>Record damages during Hydraulic Press operation</p>	<p>Introduction to machine register</p> <p>Define procedure of recording entries in register</p> <p>Importance of register</p>	<p>Computer</p> <p>Multimedia</p> <p>Record Registers</p>

LU1

For PPE (Personal Protective Equipment) details please visit Module 2 Carryout
Fleshing Hydraulic Press:

Hydraulic Press is mainly used to smooth the leather surface and also to make it shiner. It contained both temperature and Pressure which applied to leather for achieving the Result.



Following is the diagram for Ironing Machine:

Hydraulic Press Plates:

Press of leather by Hydraulic press is carrying out by attaching plates which on heating produces fine and smooth leather. There are various types of plates are available in the market these days. Following are some kind of plates describes:

- Smooth Leather Plate.
- Crocodile Pattern Plate.
- Goat grain Plate.



Importance of controls in Press Machine:

Hydraulic Press Machine have following types of controls Temperature, Pressure, Time. Leather finishing articles is varying from article to article like for garment leather low pressure and medium pressure is required and for upper leather high pressure and high temperature and more time is required and for fancy articles more gloss is required so it require more pressure and temperature.

Explain Controls of press Machine:

Following controls are major controls of ironing machine:

Temperature:

Adopting steam and heat transmission oil to heat, the temperature of the Plates working surface is equable and can be controlled automatically, with low power consumption. The temperature is quick to rise when starting the machine and go down when stopping it, with short work preparation time. For heat transmission oil, the highest temperature can reach 150°C

Pressure:

This leather press machine is produced for ironing, whose pressure is controlled by reliable hydraulic system and is continuously adjustable.

Embossing:

Leather is sometimes embossed during the tanning process. This can be done for several reasons for making leather fine and attractive and make it shiner according to articles.

Sometimes low grade leather need up gradation for this reason instead of simple iron Embossing is carried out by using different patterns of plates.

Hydraulic Press Machine Manual:

Machine manual is provided from vendor which guide operator for correct operation of machine and also helps to overcome damages.

Embossing is usually carried out in Hydraulic Pressing which leather is feed using flat stick for making leather flat and Pressed the Leather and get it from other side of the machine.

Damages due to Hydraulic Press:

Due to improper feeding and handling of machine it causes damages to the leather

For both operator and machine and leather as well.

Precautions of Hydraulic Press:

Proper handling of machine and operator should be skill to avoid damages to the leather.

LU3**Cleaning of Hydraulic Press machine, tools & equipment, workstation:**

After Completing of Embossing the machines tools and the area around the Press should be properly clean.

LU4**Entries of mechanical records:**

After Completion of every process their records should be maintained in registered for further enquires and processes.

The Record Entries should normally be carried out by writing number of skins/hides is processed and number of damaged skins/hides if any occurs should be maintained who has done the process and how much time has spent for completion of process.

HUSSAIN LEATHER CRAFT

HYDRAULIC PRESS PROCESS REGISTER

FOR THE MONTH OF _____, YEAR OF _____

Sr. No.	LOT #	PLAN #	RECEIVE DATE	PROCESS COMPLETE DATE	LEATHER TYPE	PRESSED PCS	DAMAGE PCS	TOTAL PCS	REMARKS
1									
2									
3									
4									
5									
6									
7									
8									
9									
10									

Operator Sign

Supervisor Sign

For more detailed information, please visit: Link: https://www.made-in-china.com/products-search/hot-china-products/Leather_Hydraulic_Press_Machine.html

Also Visit: <https://www.alibaba.com/showroom/leather-hydraulic-press-machine.html>

VIDEOS:

	Video Link
	<p>Perform Hydraulic Press</p> <p>https://youtu.be/RPn8n6JSHnQ</p> <p>https://www.youtube.com/watch?v=cETYFY4vigQ</p> <p>https://www.youtube.com/watch?v=2HycrhvmY5E</p> <p>https://www.youtube.com/watch?v=aWdDpDr0eVo</p>

LEATHER PROCESSING TECHNOLOGIST



© TVET SSP

Module-15
LEARNER GUIDE
National Vocational Certificate Level 2

Version 1 - September, 2019

Module15: Carryout Ironing

Objective of the module: The aim of this module to develop advanced knowledge, skills and understanding to carryout ironing

Duration: 40 Hours **Theory:** 8 Hours **Practical:** 32 Hours

Learning Unit	Learning Outcomes	Learning Elements	Materials Required
LU1: Prepare Workstation for Ironing	<p>The trainee will be able to:</p> <p>Remove hazardous from workplace</p> <p>Analyze Job card from supervisor</p> <p>Set Ironing machine as per requirement</p>	<p>Define PPE</p> <p>State importance of PPE at workstation</p> <p>Enlist the hazardous</p> <p>Define the risks involved in case hazardous materials are not removed.</p> <p>Define job card</p> <p>Introduction to Ironing machine.</p> <p>Feed roller</p> <p>Pressure roller</p> <p>Iron roller</p> <p>Importance of controls in ironing machine</p> <p>Explain controls of ironing machine</p>	<p>Computer</p> <p>Multimedia</p> <p>Safety helmet & glasses</p> <p>Safety Gloves</p> <p>Safety Shoes</p> <p>Earplugs</p> <p>Safety Uniform</p> <p>Ironing Machine</p> <p>Ironing Machine Operator Manual</p> <p>Tool Kits</p>
LU2: Perform Ironing	<p>The trainee will be able to:</p> <p>Feed Leather into Ironing machine</p> <p>Operate Ironing machine as per</p>	<p>Define Ironing</p> <p>Purpose of Ironing</p> <p>Introduction to Ironing machine manual</p>	<p>Computer</p> <p>Multimedia</p> <p>Ironing Machine</p> <p>Ironing Machine Operator Manual</p>

	<p>requirement</p> <p>Examine Ironing impact on leather as per requirement</p> <p>Pile leather</p>	<p>Introduction to Ironing process</p> <p>Perform Ironing</p> <p>Define damages during ironing</p> <p>Reasons of damages during ironing</p> <p>Precautions to take during ironing</p>	<p>Hide</p> <p>Skin</p> <p>Tools Kits</p> <p>Pallet Jack</p>
LU3:Clean Work place	<p>The trainee will be able to:</p> <p>Clean machine as per instruction</p> <p>Ensure housekeeping of workplace</p>	<p>Introduction to cleaning of;</p> <ul style="list-style-type: none"> ○ Ironing machine ○ workstation 	<p>Computer</p> <p>Multimedia</p> <p>Ironing Machine</p> <p>Ironing Machine Operator Manual</p> <p>Air Blower</p>
LU4: Maintain Ironing machine register	<p>The trainee will be able to:</p> <p>Record Ironing operation entries in register</p> <p>Record damages during Ironing operation</p>	<p>Introduction to machine register</p> <p>Define procedure of recording entries in register</p> <p>Importance of register</p>	<p>Computer</p> <p>Multimedia</p> <p>Record Registers</p>

LU1

For PPE (Personal Protective Equipment details please visit Module 2 Carryout Fleshing

Introduction to Ironing machine:

Leather Ironing Machine is mainly used for smooth the leather or to make it shinier it is also ironed to soften thermoplastic binders and to fuse them into a coherent film. Temperatures above 70 ° C are required.

Following is the diagram for Ironing Machine



Roto Machine

Fini flex (for Light Leather)

Feed Roller:

This is special type of roller which is made by synthetic wool fibers it is used for convey the leather into the machine.

Pressure Roller:

It is used for making pressure into the leather during ironing.

Iron Roller:

The ironing roller is made of high quality steel. Its surface achieves mirror finish through fine processing.

Importance of controls in ironing Machine:

Ironing Machine have following types of controls Temperature, Pressure, and Time. Leather finishing articles is varying from article to article like for garment leather low pressure and medium pressure is required and for upper leather high pressure and high temperature and more time is required and for fancy articles more gloss is required so it require more pressure and temperature.

Following controls are major controls of ironing machine:

Temperature:

Adopting steam and heat transmission oil to heat, the temperature of the roller's working surface is equable and can be controlled automatically, with low power consumption. The temperature is quick to rise when starting the machine and go down when stopping it, with short work preparation time. For heat transmission oil, the highest temperature can reach 150°C

Pressure:

This leather processing machine is produced for two-grade ironing, whose pressure is controlled by reliable hydraulic system and is continuously adjustable. (Adjustable range: 0—10Mpa)

Ironing:

Leather is sometimes ironed during the tanning process. This can be done for several reasons for making leather fine and smooth and make it shiner.

Smooth leather is also less sensitive and easier to clean than the rough, unbleached leather. However, it is also ironed to soften thermoplastic binders and to fuse them into a coherent film. Temperatures above 70 ° C are required. Because the finish is made up of several layers, the same leather may have to be ironed several times.

Ironing Machine Manual:

Machine manual is provided from vendor which guide operator for correct operation of machine and also helps to overcome damages.

Ironing is usually carried out in Roto Machine or finiflex (for light leather) in which leather is feed using feeding conveyor and Ironed the skins/hides and get it from other side of the machine.

Damages due to Ironing:

Due to improper feeding and handling of machine it causes damages to the leather
For both operator and machine and leather as well.

Precautions to take during Ironing:

Proper handling of machine and operator should be skill to avoid damages to the leather.

LU3**Cleaning of Hydraulic Press machine, tools & equipment, workstation:**

After Completing of Embossing the machines tools and the area around the Press should be properly clean.

LU4

Entries of mechanical records:

After Completion of every process their records should be maintained in registered for further enquires and processes.

The Record Entries should normally be carried out by writing number of skins/hides is processed and number of damaged skins/hides if any occurs should be maintained. who has done the process and how much time has spent for completion of process.

VIDEOS:

	Video Link
	<p>Perform Leather Measuring</p> <p>https://www.youtube.com/watch?v=BULEptANU24</p> <p>https://www.youtube.com/watch?v=HX8z80p4lnA</p> <p>https://www.youtube.com/watch?v=jPWhz9fwZUc</p> <p>https://www.youtube.com/watch?v=BULEptANU24</p>

HUSSAIN LEATHER CRAFT
MEASURING PROCESS REGISTER
 FOR THE MONTH OF _____, YEAR OF _____

Sr. No.	LOT #	PLAN #	RECEIVE DATE	PCS	SQ.FT	ITEM/ARTICLE	ACTUAL PCS	ACTUAL SQ.FT	SHORTAGE %	COMPLETE DATE	REMARKS
1											
2											
3											
4											
5											
6											
7											
8											
9											
10											

 Operator Sign

 Supervisor Sign

<https://www.mastrotto.com/tanning-process/>

VIDEOS:

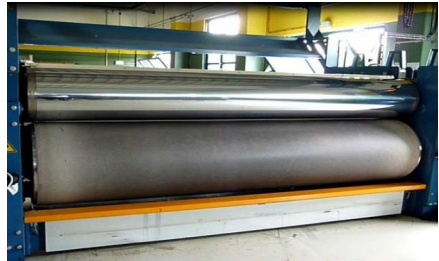
	Video Link
	<p>Perform Ironing</p> <p>https://youtu.be/Lrbp8oEUxqc</p> <p>https://www.youtube.com/watch?v=OicclK6KCdY</p> <p>https://www.youtube.com/watch?v=22qIBfXGHvA</p> <p>https://www.youtube.com/watch?v=l76qzLn3-5E</p>

LEATHER PROCESSING TECHNOLOGIST



© TVET SSP

Module-16

LEARNER GUIDE

National Vocational Certificate Level 2

Version 1 - September, 2019

Module 16: Carryout Leather Measuring

Objective of the module: The aim of this module to develop advanced knowledge, skills and understanding to carryout leather measuring

Duration: 40 Hours **Theory:** 8 Hours **Practical:** 32 Hours

Learning Unit	Learning Outcomes	Learning Elements	Materials Required
LU1: Prepare Workstation for Leather Measuring	<p>The trainee will be able to:</p> <p>Remove hazardous material from workplace</p> <p>Analyze Job card from supervisor</p> <p>Set Measuring machine as per requirement</p>	<p>Define PPE</p> <p>State importance of PPE at workstation</p> <p>Enlist the hazardous materials</p> <p>Define the risks involved in case hazardous materials are not removed.</p> <p>Define job card</p> <p>Introduction to Leather Measuring machine.</p>	<p>Computer</p> <p>Multimedia</p> <p>Safety helmet & glasses</p> <p>Safety Gloves</p> <p>Safety Shoes</p> <p>Earplugs</p> <p>Safety Uniform</p> <p>Leather Measuring Machine</p> <p>Leather Measuring Machine Operator Manual</p>
LU2: Perform Leather Measuring	<p>The trainee will be able to:</p> <p>Place Leather on Measuring machine</p> <p>Operate Measuring machine according as per requirement</p> <p>Pile Measured Leather</p>	<p>Define Measuring</p> <p>Purpose of Measuring</p> <p>Introduction to Measuring machine manual</p> <p>Introduction to Measuring process</p> <p>Perform measuring on measuring machine</p>	<p>Computer</p> <p>Multimedia</p> <p>Leather Measuring Machine</p> <p>Leather Measuring Machine Operator Manual</p> <p>Hide</p> <p>Skin</p> <p>Tool Kits</p>

			Measuring Tape
LU3:Clean work place	The trainee will be able to: Clean machine as per instruction Ensure housekeeping of workplace	Introduction to cleaning of; <ul style="list-style-type: none"> ○ Leather Measuring Machine ○ workstation 	Computer Multimedia Leather Measuring Machine Leather Measuring Operator Manual Air Blower
LU4: Maintain Leather Measuring machine register	The trainee will be able to: Record Measuring operation entries in register Record Measurement of leather	Introduction to machine register Define procedure of recording entries in register Importance of register	Computer Multimedia Record Registers

LU1

For PPE (Personal Protective Equipment details please visit Module 2 Carryout Fleshing

LU2

Introduction to Leather Measuring Machine:

Leather Measuring Machine is used for measuring area of leather it can be of wet blue or crust or finish leather before going to further process.

more Going to another Department e.g. from tanning to wet end department leather is usually measured for further processing. So, in the coming process chemicals and auxiliaries are use according to area given.



A hide or skin is usually measured for making up an animal skin/hide for further processing. When measuring of leather, the exact area of leather will be given.

Measuring Manual:

Measuring machine is usually operated by operator after following manuals for reduce damages and injuries.

Measuring is carried out by feeding leather into measuring machine and handled by operator by placing the leather on machine and computer attached with Machine guide the area of leather and it stamped on flesh side of leather.

LU3

Cleaning of Measuring machine, tools & equipment, workstation:

After Completing of measuring the machines and its tools and the area around the measuring should be properly washout and clean.

LU4

Entries of mechanical records:

After Completion of every process their records should be maintained in registered for further enquires and processes.

The Record Entries should normally be carried out by writing number of skins/hides is processed and number of damaged skins/hides if any occurs should be maintained. Who has done the process and how much time has spent for completion of process.

HUSSAIN LEATHER CRAFT
MEASURING PROCESS REGISTER
 FOR THE MONTH OF _____, YEAR OF _____

Sr. No.	LOT #	PLAN #	RECEIVE DATE	PCS	SQ.FT	ITEM/ARTICLE	ACTUAL PCS	ACTUAL SQ.FT	SHORTAGE %	COMPLETE DATE	REMARKS
1											
2											
3											
4											
5											
6											
7											
8											
9											
10											

 Operator Sign

 Supervisor Sign

[nd weights](#)

Also Visit: <http://www.fsw.cc/best-methods-measuring-leather-thickness/>

VIDEOS:

	Video Link
	<p>Perform Leather Measuring</p> <p>https://www.youtube.com/watch?v=BULEptANU24</p> <p>https://www.youtube.com/watch?v=HX8z80p4lnA</p> <p>https://www.youtube.com/watch?v=jPWHz9fwZUc</p> <p>https://www.youtube.com/watch?v=BULEptANU24</p>

Module Title and Aim	Learning Units	Theory Days/hours	Workplace Days/hours	Timeframe of modules
<p>Module 1: Comply Personal Health and Safety Guidelines</p> <p>Aim: This Competency Standard identifies the competencies required to protect/apply occupational Safety, Health and Environment at workplace according to the industry's approved guidelines, procedures and interpret environmental rules/regulations. Trainee will be expected to identify and use Personal Protective Equipment (PPE) according to the work place requirements. The underpinning knowledge regarding Observe Occupational Safety and Health (OSH) will be sufficient to provide the basis for the job at workplace.</p>	<p>LU1: Identify Hazard at work place</p> <p>LU2: Apply personal protective and safety equipment (PPE).</p> <p>LU3: Observe occupational safety and health (OSH)</p> <p>LU4: Dispose of hazardous waste/materials</p>	6	24	30

Module Title and Aim	Learning Units	Theory Days/hours	Workplace Days/hours	Timeframe of modules
<p>Module 2: Communicate the Workplace Policy and Procedure</p> <p>Aim: This unit describes the performance outcomes, skills and knowledge required to develop communication skills in the workplace. It covers gathering, conveying and receiving information, along with completing assigned written information under direct supervision.</p>	<p>LU1. Identify workplace communication procedures</p> <p>LU2. Communicate at workplace</p> <p>LU3. Draft Written Information Review Documents</p>	4	16	20

Module Title and Aim	Learning Units	Theory Days/hours	Workplace Days/hours	Timeframe of modules
<p>Module 3: Perform Basic Communication (Specific)</p> <p>Aim: This unit describes the skills and knowledge required to assist in the development of communication competence by providing information regarding different forms of communication and their appropriate use.</p>	<p>LU1. Communicate in a team to achieve intended outcomes</p> <p>LU2. Follow Supervisor's instructions as per organizational SOPs</p> <p>LU3. Develop Generic communication skills at workplace</p>	6	24	30
<p>Module 4: Perform Basic Computer Application (Specific)</p> <p>Aim: This unit describes the skills and knowledge required to use spreadsheet to prepare a page of document, develops familiarity with Word, Excel, email, and computer graphics basics.</p>	<p>LU1. Create Word Documents</p> <p>LU2. Create Excel Documents</p> <p>Use internet for Browsing</p>	8	32	40

Module Title and Aim	Learning Units	Theory Days/hours	Workplace Days/hours	Timeframe of modules
Module 5: Carryout Fleshing Aim: to train the trainee about fleshing operations	LU1: Prepare workstation for fleshing LU2: Perform fleshing LU3: Clean workplace LU4: Maintain fleshing register LU5:	8	32	40
Module 6: Carryout Scudding Aim: to train the trainee about scudding of leather	LU1: Prepare workstation for scudding LU2: Perform scudding LU3: Clean workplace LU4: Maintain scudding register	8	32	40
Module 7: Carryout Splitting Aim: to train the trainee about splitting of leather	LU1: Prepare workstation for splitting LU2: Perform splitting LU3: Clean workplace LU4: Maintain splitting register	8	32	40
Module 8: Carryout Shaving Aim: to train the trainee about leather shaving	LU1: Prepare workstation for shaving LU2: Perform shaving LU3: Clean workplace LU4: Maintain shaving register	8	32	40
Module 9: Carryout Sammying-Setting Aim: to train the trainee about sammying & setting out of leather	LU1: Prepare workstation for sammying & setting out LU2: Perform sammying & setting out LU3: Clean workplace LU4: Maintain sammying & setting out register	8	32	40
Module 10: Carryout Drying Aim: to train the trainee about leather drying	LU1: Prepare workstation for drying LU2: Perform drying LU3: Clean workplace LU4: Maintain drying register	8	32	40

Module Title and Aim	Learning Units	Theory Days/hours	Workplace Days/hours	Timeframe of modules
Module 11: Carryout Staking Aim: to train the trainee about leather staking	LU1: Prepare workstation for staking LU2: Perform staking LU3: Clean workplace LU4: Maintain staking register	8	32	40
Module 12: Carryout Toggling Aim: to train the trainee about toggling	LU1: Prepare workstation for toggling LU2: Perform toggling LU3: Clean workplace LU4: Maintain toggling register	8	32	40
Module 13: Carryout Buffing Aim: to train the trainee about buffing on leather	LU1: Prepare workstation for buffing LU2: Perform buffing LU3: Clean workplace LU4: Maintain buffing register	8	32	40
Module 14: Carryout Hydraulic Press Aim: to train the trainee about creating effects through hydraulic press	LU1: Prepare workstation for hydraulic press LU2: Perform hydraulic press LU3: Clean workplace LU4: Maintain hydraulic press register	8	32	40
Module 15: Carryout Ironing Aim: to train the trainee about leather ironing	LU1: Prepare workstation for Ironing LU2: Perform ironing LU3: Clean workplace LU4: Maintain Ironing register	8	32	40
Module 16: Carryout Measuring Aim: to train the trainee about leather measuring	LU5: Prepare workstation for measuring LU6: Perform leather measuring LU7: Clean workplace LU8: Maintain measuring register	8	32	40
	Total	120	480	600

Frequently Asked Questions

<p>1. What is Competency Based Training (CBT) and how is it different from currently offered trainings in institutes?</p>	<p>Competency-based training (CBT) is an approach to vocational education and training that places emphasis on what a person can do in the workplace as a result of completing a program of training. Compared to conventional programs, the competency based training is not primarily content based; it rather focuses on the competence requirement of the envisaged job role. The whole qualification refers to certain industry standard criterion and is modularized in nature rather than being course oriented.</p>
<p>2. What is the passing criterion for CBT certificate?</p>	<p>You shall be required to be declared “Competent” in the summative assessment to attain the certificate.</p>
<p>3. What are the entry requirements for this course?</p>	<p>The entry requirement for this course is 8th Grade or equivalent.</p>
<p>4. How can I progress in my educational career after attaining this certificate?</p>	<p>You shall be eligible to take admission in the National Vocational Certificate Level-3 in Leather Products Development Technician (Pattern Maker). You shall be able to progress further to National Vocational Certificate Level-4 in Leather Products Development Technician (Computerized Pattern Designer); and take admission in a level-5, DAE or equivalent course. In certain case, you may be required to attain an equivalence certificate from The Inter Board Committee of Chairmen (IBCC).</p>
<p>5. If I have the experience and skills mentioned in the competency standards, do I still need to attend the course to attain this certificate?</p>	<p>You can opt to take part in the Recognition of Prior Learning (RPL) program by contacting the relevant training institute and getting assessed by providing the required evidences.</p>
<p>6. What is the entry requirement for Recognition of Prior Learning program (RPL)?</p>	<p>There is no general entry requirement. The institute shall assess you, identify your competence gaps and offer you courses to cover the gaps; after which you can take up the final assessment.</p>
<p>7. Is there any age restriction for entry in this course or Recognition of Prior Learning program (RPL)?</p>	<p>There are no age restrictions to enter this course or take up the Recognition of Prior Learning program</p>

8. What is the duration of this course?	The duration of the course work is 1,510 hrs. (11 months)
9. What are the class timings?	The classes are normally offered 25 days a month from 08:00am to 01:30pm. These may vary according to the practices of certain institutes.
10. What is equivalence of this certificate with other qualifications?	As per the national vocational qualifications framework, the level-4 certificate is equivalent to Matriculation. The equivalence certificate can be obtained from The Inter Board Committee of Chairmen (IBCC).
11. What is the importance of this certificate in National and International job market?	This certificate is based on the nationally standardized and notified competency standards by National Vocational and Technical Training Commission (NAVTTTC). These standards are also recognized worldwide as all the standards are coded using international methodology and are accessible to the employers worldwide through NAVTTTC website.
12. Which jobs can I get after attaining this certificate? Are there job for this certificate in public sector as well?	You shall be able to take up jobs in the leather products making companies in the functions of cutting, stitching and finishing of leather gloves and garments.
13. What are possible career progressions in industry after attaining this certificate?	You shall be able to progress up to the level of supervisor after attaining sufficient experience, knowledge and skills during the job. Attaining additional relevant qualifications may aid your career advancement to even higher levels.
14. Is this certificate recognized by any competent authority in Pakistan?	This certificate is based on the nationally standardized and notified competency standards by National Vocational and Technical Training Commission (NAVTTTC). The official certificates shall be awarded by the relevant certificate awarding body.
15. Is on-the-job training mandatory for this certificate? If yes, what is the duration of on-the-job training?	On-the-job training is not a requirement for final / summative assessment of this certificate. However, taking up on-the-job training after or during the course work may add your chances to get a job afterwards.
16. How much salary can I get on job after attaining this certificate?	The minimum wages announced by the Government of Pakistan in 2019 are PKR 17,500. This may vary in subsequent years and different regions of the country. Progressive employers may pay more than the mentioned amount.
17. Are there any alternative certificates	There are some short courses offered by some training institutes on this subject.

which I can take up?	Some institutes may still be offering conventional certificate courses in the field.
18.What is the teaching language of this course?	The teaching language of this course is Urdu and English.
19.Is it possible to switch to other certificate programs during the course?	There are some short courses offered by some training institutes on this subject. Some institutes may still be offering conventional certificate courses in the field.
20.What is the examination / assessment system in this program?	Competency based assessments are organized by training institutes during the course which serve the purpose of assessing the progress and preparedness of each student. Final / summative assessments are organized by the relevant qualification awarding bodies at the end of the certificate program. You shall be required to be declared “Competent” in the summative assessment to attain the certificate.
21.Does this certificate enable me to work as freelancer?	You can start your small business of stitching leather garments, gloves of other products. You may need additional skills on entrepreneurship to support your initiative.

Test Yourself

Module 5

1. Fleshing is
 - a. Removing flesh from skin/hide
 - b. Removing hairs from skin/hide
 - c. Resizing skin/hide
 - d. Cutting edges from skin/hide
2. What is green fleshing?

3. List down importance of fleshing

4. What are types of fleshing?

5. What are precautionary step should take in fleshing?

6. At what stage green fleshing is done?

7. Remove of hair & wool is called Fleshing?
 - a. True
 - b. False

Module 6

1. What is scudding?
2. Write importance of scudding?
3. Epidermal debris and fine hair roots are mechanically removed by the scudding operation
True False
4. Which test is performed to check scudding?
5. Scudding is performed on which equipment. Pile horse
 - Table
 - Drum
 - Curved Beam (Correct Answer)
6. Scudding is perform on which side of pelt?

Module 7

1. What is purpose of splitting?

2. On which stage we can perform splitting?

3. We can split leather into
 - a. Grain Leather & Split Leather (Correct Answer)
 - b. Skin/Hide
 - c. Pelt
 - d. None of above

4. _____ is use in splitting machine
 - a. Curved Knife
 - b. Cutter
 - c. 8" Knife
 - d. Belt Knife/Blade (Correct Answer)

5. We cannot adjust splitting machine according to thickness of leather
 - a. True
 - b. False

6. Roll machines with cutting blades are used to further reduce the leather to the thickness required
 - a. True
 - b. False

Module 8

1. Define Shaving operation?

2. Write benefit of shaving on leather?

3. Shaving Machine is used for
 - a. Un-hairing the leather (Correct Answer)
 - b. Nap the leather
 - c. Removing creases from leather
 - d. Adjusting thickness of leather
4. What are precautionary measure for shaving process?

5. How many types of shaving machines are there?
 - a. 1
 - b. 2
 - c. 3
 - d. 5
6. Setting a gauge of shaving machine is essential in shaving process
 - a. True
 - b. False

Module 9

1. Why we do Sammying & Setting of leather?

2. Write benefit of Sammying & Setting on leather?

3. Which **TWO** of the following are reasons for performing sammying & setting of leather.

4. Which of the following are reasons for performing sammying & setting of leather. Tick all that apply.
 - a. Removing moisture from leather
 - b. Removing creases from leather
 - c. A & B Both (Correct Answer)
 - d. None of Above

5. Sammying Setting is perform during post pelt operation?
 - a. True
 - b. False

6. How many types of rollers are used in Sammying & Setting machines?
 - a. 1
 - b. 2
 - c. 3
 - d. 5

7. Do we need to take some precautionary steps before performing sammying setting
 - a. True
 - b. False

Module 10

1. How many approx. days required for hang drying?
 - a. 1Day (Correct Answer)
 - b. 3 Days
 - c. 5 Days
 - d. 4 Days

2. What type of articles required for Vacuum Drying?
 - a. Shoe Upper/ Lining Leather (Correct Answer)
 - b. Garments.
 - c. Gloving
 - d. Split

3. Which Drying method is used for garment Leather?
 - a. Vacuum Drying
 - b. Paste drying
 - c. Hang drying (Correct Answer)
 - d. Air Drying

4. Which Drying method is used for Shoe Upper/Lining Leather?
 - a. Hang Drying
 - b. Vacuum Drying (Correct Answer)
 - c. Toggle Drying
 - d. Pressure Drying

5. How to check moisture of Dried Leather?

6. What is the reason for drying?

7. Explain three types of Drying?

8. Is it necessary that drying should be carried out after vacuum drying?

Module 11

1. Why staking operation is performed?

2. What are the types of staking?

3. Molisa leather is used for
 - a. Show upper leather
 - b. Belt leather
 - c. Both of them
 - d. None of them

4. What are precautionary measure for staking process?

4. What are precautionary measure for shaving process?

5. Toggling is the most time consuming in terms of labor?
 - a. True
 - b. False

6. Can we perform toggling on above 100C?
 - a. True
 - b. False

Module 13

1. What will be the effect on leather after buffing?

2. When we use buffer paper no. 1200?

3. When we use buffing paper no. 180-220

4. What are precautionary measure for shaving process?

5. Buffing is performed on
 - a. Grain Side
 - b. Flesh Side
 - c. Both of them
 - d. None of them

6. Buffing is performed on crust leather?
 - a. True
 - b. False

Module 14

1. What is for Hydraulic Press?

2. Write importance of Hydraulic Press?

3. What are the precautionary measures steps of hydraulic press?

4. We can perform hydraulic press on _____ side of leather?
 - a. Grain
 - b. Flesh
 - c. Split
 - d. None of above

5. Hydraulic Press can be performed on which pre pelt

6. Hydraulic Press machine is adjusted via
 - a. Heat
 - b. Pressure
 - c. Time
 - d. All of above

Module 15

1. What is purpose of toggling operation?

2. In toggling process, the range of temperature is from
 - a. 40 to 60 C
 - b. 60 to 80 C
 - c. 80 to 100 C
 - d. 30 to 50 C
3. Hides are stretched gently through the use of
 - a. Toggle (Correct Answer)
 - b. Clamps
 - c. Clips
 - d. Pins

4. What are precautionary measure for shaving process?

5. Toggling is the most time consuming in terms of labor?

5. We can use measuring machine for raw hide/skin measuring
 - a. True
 - b. False

